

Proyecto Fin de Máster

Ingeniería Industrial

Development of a code for the design and optimization of Organic Rankine Cycles for power generation

Autor: Jaime Víctor Hernández Campo

Tutor: David Tomás Sánchez Martínez

Co-tutor: Francesco Crespi

Dpto. Ingeniería Energética
Escuela Técnica Superior de Ingeniería
Universidad de Sevilla

Sevilla, 2020



GMTS | GRUPO DE MAQUINAS Y MOTORES
TERMICOS DE SEVILLA

Proyecto Fin de Máster
Ingeniería Industrial

Development of a code for the design and optimization of Organic Rankine Cycles for power generation

Autor:

Jaime Víctor Hernández Campo

Tutor:

David Tomás Sánchez Martínez

Co-tutor:

Francesco Crespi

Dpto. de Ingeniería Energética
Área de máquinas y motores térmicos

Escuela Técnica Superior de Ingeniería
Universidad de Sevilla

Sevilla, 2020

Proyecto Fin de Máster: Development of a code for the design and optimization of Organic Rankine Cycles
for power generation

Autor: Jaime Víctor Hernández Campo

Tutor: David Tomás Sánchez Martínez

Co-tutor: Francesco Crespi

El tribunal nombrado para juzgar el Proyecto arriba indicado, compuesto por los siguientes miembros:

Presidente:

Vocales:

Secretario:

Acuerdan otorgarle la calificación de:

Sevilla, 2020

El Secretario del Tribunal

Agradecimientos

En el terreno personal, un agradecimiento inconmensurable a mis padres Francisco Manuel Hernández Aja y María Esperanza Campo Font, cuyo apoyo ha sido y continúa siendo fundamental en cada paso. Sin olvidar jamás a los amigos que he hecho en el camino, a través de los cuales he crecido.

En lo académico, el correspondiente al Dr. David Sánchez por brindarme el brillante privilegio de realizar este singular trabajo en un entorno incomparable como es el grupo de investigación del CREALab del Politecnico de Milán. En el cual encontré enormes ayudas personificadas en el profesor Alberto Guardone y su alumna de doctorado, Camilla Conti. Así como a Francesco Crespi, por su soporte técnico y dedicación en la materialización de este documento.

Las contribuciones de cada una de estas personas han sido cruciales para lograr este objetivo.

A mi tierra, a mis orígenes
Jaime Víctor Hernández Campo
Sevilla, 2020

Abstract

The aim of the present work is the parametric optimization of Organic Rankine Cycles (ORC) for its main application to medium-low temperature generic sources. For this purpose, a Matlab® [1] computational code has been developed, in which design parameters, mass flow ratios, cycle configuration and fluid selection (including mixtures) are simultaneously optimized to offer the best combination of variables for the maximization of the efficiency. Given its extraordinary reliability the reference thermodynamic database of the choice has been REFPROP® [2] v.9.1. The results accomplished for pure fluid configurations show great adaptability to previous validated optimization studies. Whereas, those for mixtures support the theoretical evidence that there is a significant efficiency growth to be accomplished when combining organic pure fluids into binary zeotropic mixtures.

The main improvements of the present work with respect to previous ORC optimization studies are, in one hand the emphasis on looking for the most suitable mathematical method for optimization of variables, previous works lack more exhaustive considerations when choosing the theoretical nature of algorithm, for this purpose multiple algorithms had been put to test running the same model, concluding that heuristic and stochastic algorithms provide more accurate results in the job of converging to global optimal. In the other hand, regarding the specifics of ORC optimization, the goal of this work is to first develop a reliable computational tool for the analysis and optimization of ORC and then verify it in order to expand its performance to include the analysis of binary zeotropic mixtures, which is the ultimate objective of this study.

It is a fact that the actual global situation calls for renewable and robust solutions for the energy production, these being one of the main reasons why there is a substantial increase of industries interest regarding the ORC technology. Aiming to represent a humble contribution to the promising future, this work pretends to create an enlightening tool for the study of different ORC configurations and potential scenarios in the upcoming energy production world.

Index

| | |
|---|-------------|
| Acknowledgments | vii |
| Abstract | ix |
| Index | xi |
| Tables index | xiii |
| Figures index | xv |
| Notation | xvii |
| Introduction | xix |
| 1 Review of the state of the art of optimization processes | 1 |
| 2.1. <i>Origins</i> | 1 |
| 2.2. <i>State of the art</i> | 1 |
| 2 System modeling | 7 |
| 2.1. <i>Model description</i> | 7 |
| 2.2. <i>Model INPUTS</i> | 9 |
| 2.3. <i>Thermodynamic model</i> | 11 |
| 2.4. <i>Model OUTPUTS</i> | 14 |
| 3 Optimization Method | 21 |
| 3.1. <i>Mathematical Algorithm</i> | 21 |
| 3.2. <i>Optimization Modeling</i> | 23 |
| 3.2.1. <i>Objective function</i> | 23 |
| 3.2.2. <i>Penalization functions</i> | 23 |
| 3.2.3. <i>Working fluid optimization</i> | 26 |
| 4 Verification | 28 |
| 4.1. <i>Reference studies</i> | 28 |
| 4.2. <i>Verification with Astolfis study</i> | 29 |
| 4.3. <i>Verification with Maravers study</i> | 32 |
| 4.4. <i>Observations on verification process</i> | 33 |
| 5 Results | 35 |
| 5.1. <i>Guidelines for mixture optimization</i> | 35 |
| 5.2. <i>Mixture optimization results</i> | 35 |
| 5.3. <i>Mixture optimization outputs</i> | 36 |
| 6 Conclusions and future developments | 38 |
| 6.1. <i>Conclusions</i> | 38 |
| 6.2. <i>Future developments</i> | 39 |
| References | 41 |

TABLE INDEX

| | |
|---|----|
| Table 1. Configurations paramters | 9 |
| Table 2. Efficiency of equipment and vapor quality | 9 |
| Table 3. Cycle defining parameters | 10 |

FIGURES INDEX

| | |
|--|----|
| Figure 1. Classification of organic fluids attending to their saturation shape in the T-s diagram | 2 |
| Figure 2. Standard layout of an basic ORC cycle (a) and regenerated ORC (b) | 7 |
| Figure 3 a). Subcritical Temperature-Entropy layout diagram | 8 |
| Figure 3 b). Supercritical Temperature-Entropy layout diagram | 8 |
| Figure 4 a). Design parameters in subcritical T-s | 10 |
| Figure 4 b). Design parameters in subcritical T-s diagram | 10 |
| Figure 5. T-s diagram differences between pure fluids and mixtures | 11 |
| Figure 6. Flow chart of thermodynamic algorithm | 13 |
| Figure 7 a). Temperature-Entropy diagram for a subcritical analysis of R245FA | 15 |
| Figure 7 b). Temperature-Entropy diagram for a supercritical analysis of MM | 16 |
| Figure 8. Close up view to pinch point location in supercritical cycle of MM.. | 16 |
| Figure 9 a). T-Q diagram for hot source under Subcritical conditions | 17 |
| Figure 9 b). T-Q diagram for hot source under Supercritical conditions. | 17 |
| Figure 9 c). T-Q diagram for cold sink | 18 |
| Figure 10. T-Q diagram for regenerator. | 19 |
| Figure 11. Output Excel file with thermodynamic states of all cycle points. | 19 |
| Figure 12. Types of children in Genetic Algorithm. | 21 |
| Figure 13. Flow chart of genetic algorithm. | 22 |
| Figure 14. Unfeasible results: Supercritical shape with wet expansion. | 23 |
| Figure 15. T-s diagram for mixture RC318 and R142b optimization | 26 |
| Figure 16. Verification with Astolfis optimization work, reinjection limit applies. | 29 |
| Figure 17. Verification with Astolfis optimization work, no reinjection limit. | 31 |
| Figure 18. Verification with Maraver optimization work. | 32 |
| Figure 19. Mixture results. | 36 |
| Figure 20. T-s Diagram for a mixture of RC318 and R142B. | 38 |

Notation

| | |
|--------------------------|--|
| T | Temperature (°C) |
| p | Pressure (bar) |
| h | Enthalpy (KJ / Kg) |
| s | Entropy (KJ / Kg K) |
| $\Delta T_{pp,PHE}$ | Pinch point temperature difference at primary heat exchanger |
| $\Delta T_{pp,rec}$ | Pinch point temperature difference at recuperator |
| $\Delta T_{ap,cond}$ | Approach temperature difference at condenser outlet |
| $\Delta T_{ap,cond}^*$ | Approach temperature difference at condenser inlet |
| $\Delta T_{sc,cond}$ | Subcooling temperature difference in condenser |
| $\Delta T_{sc,evap}$ | Subcooling temperature difference in evaporator |
| $\eta_{is,turb}$ | Isentropic turbine efficiency |
| $\eta_{is,pump}$ | Isentropic pump efficiency |
| $\eta_{mec-elec,turb}$ | Electromechanic turbine efficiency |
| $\eta_{mec-elec,pump}$ | Electromechanic pump efficiency |
| $\eta_{gear\ box}$ | Gear box efficiency |
| vq_{min} | Min vapor quality |
| $P_{in,turb}$ | Inlet turbine pressure |
| $\Delta T_{ap,PHE}$ | Approach temperature difference at PHE |
| $\Delta T_{pp,PHE}$ | Pinch point temperature difference at PHE |
| $\Delta T_{ap,cond}$ | Approach temperature difference at condenser |
| $\Delta T_{pp,cond}^*$ | Modified pinch point difference at condenser |
| $\Delta T_{pp,rec}$ | Pinch point difference at recuperator |
| W_{net} | Net work output |
| \dot{Q}_{in} | Net heat introduced |
| η_{cycle} | Cycle efficiency |
| ϵ_{rec} | Recuperator effectivity |
| η_{plant} | Plant efficiency |
| $\eta_{lorentz}$ | Lorentz efficiency |
| η_{II} | Second law efficiency |
| m_{HS-WF} | Mass flow ratio of hot source fluid to working fluid |
| m_{WF-CS} | Mass flow ratio of working fluid to cold fluid |
| P_i | Cycle point i |
| PHE | Primary Heat Exchanger |
| T_{amb} | Ambient temperature |
| T_{limit} | Limit temperature fro REFPROP accuracy |
| $T_{reinjection\ limit}$ | Reinjection limit temperature |
| σ | Standard deviation |

Introduction

Over the last recent years, the attention on ORC technology has been constantly growing, this can be explained by the multiple interests gathering around this field that makes it extremely convenient for the energy sector.

In one hand there is the global concern on reducing the consumption of fossil fuels as well as the emissions of several contaminating gases (carbon dioxide, green house and pollutants mainly) that are permanently contributing to the severely damaged environment. Attending this issue, ORC systems contribute by making use of renewable heat sources as solar [3-5], geothermal [6-8], biomass [9] and waste heat recovery from combustion engines [11-14]. Although the latest application is not directly renewable, the use of ORCs has proven to efficiently recover a large amount of the profitable wasted heat generated from power production industry (50-60% of waste heat) thus making a substantial contribution to reduce the fossil fuel consumption of primary engines as well as diminishing the damage of emissions by lowering the temperature of exhaust gases.

Even though steam cycles will probably persist as the most competitive technology for high temperature heat sources, it occurs that when sources are below the 150-170°C range (typical of most common renewable sources) water should be throttled to such low pressures that a very poor thermodynamic efficiency results, thus its performance at low-grade sources has no comparison to ORCs, which presents significant number of preferable reasons:

- Remarkably better cycle and heat recovery efficiencies due to a much favorable thermodynamic cycle shape, even with simple layouts.
- Low turbine mechanical stress due to low peripheral speed leading to low turbine RPM that allow the direct drive of the electric generator without gear reduction.
- No erosion of blades thanks to the absence of moisture in the vapor nozzles (dry expansion).
- Excellent partial load behavior, been able to variate flow and temperature conditions while maintaining 90% of cycle efficiency at 50% load.
- Reduced volume flow rates with low enthalpy drops in the expander, allowing for higher isentropic efficiencies, reduced size designs and more competitive manufacturing costs

Moreover, given the extraordinary adaptability of ORC and the increasing restrictions on working fluids, they are also suitable due to its capability to constrain the design for the use of fluids with low GWP, ODP and high security standards while still performing competitive efficiencies.

On the other hand, there are various economic advantages that are closely related to the previous reasons to justify the potential of ORCs, the most important is the reduced costs of the heat source and its maintenance, either if it comes from geothermal brines, waste heat recovery (WHR) or practically any renewable field, this since the nature of organic fluids brings the opportunity of exploiting low-medium heat sources ranging a wide

set of temperatures (50 – 350°C) which is commonly the spectrum for most of the cases, in consequence the heat source of the cycle is available at a low cost either in a naturally renewable way or taking advantage of industries waste.

In addition, a lot of financial incentives are arising coming from both private and public initiatives which make the exploitation even more competitive and attractive for its investment and rapid development. For all these reasonings ORC technology has proven to be one of the most promising technologies to convert medium-low grade heat into power [15 -17].

This study pretends to approach the parametric optimization of ORC focusing on the best attainable combination of thermodynamic performance and fluid selection to conclude which are the best design variables at each potential scenario.

1 REVIEW OF THE STATE OF THE ART OF OPTIMIZATION PROCESSES

This optimization review intends to be an overall view of the history in ORC optimization along with the parallel evolution of organic fluids in this technology.

2.1. Origins

Even though the principles of ORC are well known since the 60's decade, where the first binary cycle was built in 1967 in Kamchatka (operated with CFC-12), it has not been until the early 90's that the optimization of this technology started to take relevance in the power generation community, with a special focus on the fluid selection. This mainly due to the need of improving plant efficiencies and the increasing restrictions arising from the Montreal Protocol, Vienna, 1987 [19] which banned the production and usage of CFCs (and later HCFCs) as a consequence of the study made by Chemistry Nobel prize winners Mario Molina and Frank Sherwood Rowland (1995) about the ozone depletion reasons. This along with the improvements in the component technology (heat exchangers, expander, pump) and the growing complexity of fluids, boosted ORC as one of the most promising technologies to reduce contamination and exploit medium-low grade sources.

2.2. State of the art

Given the exponential growth of ORC technology over the last decades and the wide number of different approaches written about its optimization, it seems imperative to collect a chronological review of the state of the art for ORC optimization to get a deep understanding of which are the present and future needs of the field.

Regarding the initial approaches to ORC optimization, it is important to notice that, although the technology can cover a wide range of renewable applications (i.e. biomass, solar, ocean thermal and more) most of the commercial applications and hence the research efforts are focusing on two main branches, geothermal heat sources and waste heat recovery (WHR).

Invernizzi et al. [20] pointed the preference of HFCs (hydrofluorocarbons) as the auspicious R245fa or n-Pentane, over traditional CFCs (chlorofluorocarbons) and HCFCs (hydrochlorofluorocarbons) in the optimization of a geothermal brine (100 – 300°C) with the plant exergy efficiency as objective function and evaporation pressure as variable. Constraining the cycle to be subcritical, the results showed the existence of optimal temperature ranges for each fluid and the convenience of choosing fluids with a critical temperature above the heat source temperature.

Hettiarachchi et al. [21] followed the path of geothermal heat sources optimizing the ratio of total heat transfer area to total net power with the Powell Method [22] (gradient descent algorithm) and compared the results among a set of three different fluids, Ammonia, R123, n-Pentane and PF5050. The best scenario for low-temperature geothermal brine was a plant efficiency of 8.0 % for an evaporating pressure of 38.7 bar and Ammonia as working fluid.

Wei et al. [23] considered the optimization of HFC-245fa (1,1,1,3,3-pentafluoropropane) only, for its application to WHR and studied the ORC reactions to disturbances in the design parameters with respect to the nominal value. Conclusions were that increasing the exhaust flow rate or temperature lead to a better exploitation of heat source hence an improvement on system efficiency and power output. Moreover, the optimal performances were met in cycles with subcooled condensers, in which the subcooling conditions at the outlet were in the range of 0.5-0.6K. Finally, it was acknowledged that there is a strong dependency between the drop of net power output and high sink temperatures, whose rise can diminish the cycle performance up to a 30% from the nominal value.

Whilst the previous works focused on subcritical configurations primarily, Saleh et al. [24] considered supercritical configurations in comparison to subcritical for 31 pure fluids (alkanes, fluorinated alkanes, ethers and fluorinated ethers). The thermodynamic screening was conducted with BACKONE equation of state [25] for low-temperature geothermal brines in the arch of 30-100°C and the elected objective function was the thermal efficiency. Conclusions evidenced that, superheating is effective for subcritical configurations only if an Internal Heat Exchanger (IHE) is included and at the contrary, supercritical cycles suffer a decrease of thermal efficiency when superheating. Also, most of the selected fluids with a low critical temperature turned to find their optimal in subcritical configurations while those with higher critical temperature were supercritical, this infers that for heat sources above the range limit of 100°C, supercritical configurations are to be expected. The highest thermal efficiencies were found for high boiling temperature fluids with overhanging saturated vapor lines in subcritical configurations including IHE.

Dai et al. [26] optimized 10 working fluids under sub-critical conditions emphasizing the dependence of this on the saturated vapor line shape (T-s diagram), hence on the turbine work output of ORCs, distinguishing between those with a negative slope in the saturated vapor curve (i.e. wet fluids), and those with non-negative slope (i.e. dry fluids). This difference is clearly represented in Fig. 1. The software of the choice to perform the thermodynamic simulation was Fortran and REFPROP® 6.01 for the thermodynamic properties calculation. Optimization was carried out for the Exergy efficiency by means of the genetic algorithm [27] which is a great option to avoid non-global optimal solutions. Results show that, for the chosen set of fluids and temperature range (80-135°C), the lower the exhaust temperature of waste heat the higher the exergy efficiency for dry fluids, and no IHE is needed under this scenario, since it would reduce the cycle performance in recovering the waste heat in the effort of maintaining the work output. R236EA fulfills all this requirement having the highest efficiency with the lowest exhaust temperature within the tested fluids.

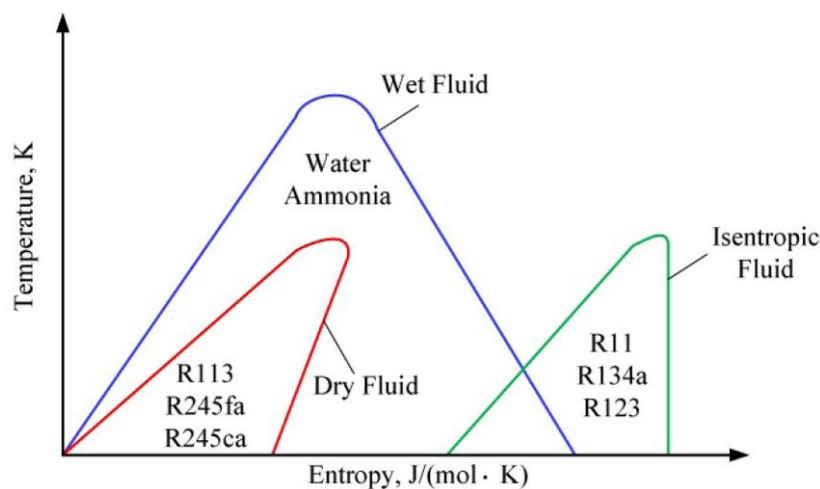

Figure 1. Classification of organic fluids attending to their saturation shape in the T-s diagram.

Continuing in the search for better performances in the promising transcritical range, Schuster et al. [28] studied the potential of supercritical ORCs. They analyzed the performance of several working fluids by means of the exergy efficiency and compared the mediums for sub- and supercritical cases. Optimization variables were, evaporation temperature and inlet temperature for subcritical and supercritical scenarios respectively. It turned out that supercritical configurations acquire higher plant efficiencies as result of the corresponding better exergetical efficiencies. The work agreed to previous studies pointing that the thermal efficiency (or cycle efficiency), as defined in Eq. (1), is not the best choice as optimization objective function, given the fact that increasing the thermal efficiency usually leads to a decrease in the heat recovery rate. This is proved analyzing the shape of the organic fluid's curve in the T-Q diagram, showing that at higher live vapor temperatures less heat is transferred and the system efficiency declines. It is rather useful to set the plant efficiency Eq. (2), as the objective function for optimization and comparison purposes. Plant efficiency improvements are directly linked with the reduction of both exergy losses and exergy destruction, hence the optimal plant efficiencies are found by looking for the lower exergy losses. Results evidenced that, for generic heat sources with temperatures around 210°C, the best fluids for subcritical cases are R245fa and iso-butene with evaporation temperatures of 140°C approximately, whilst for supercritical scenarios the most convenient combinations are either R365mfc or iso-pentane with inlet temperatures around 180°C, achieving plant efficiencies of 13.2% (subcritical) and 14% (supercritical).

Rashidi et al. [29] conducted the parametric optimization of a regenerative ORC. Exergy efficiency, specific work and thermal efficiency were selected as the objective functions to optimize the thermal parameters for different expansion pressures by using Engineering Equation Solver (EES). In the look for a good optimization approach they made a particular combination of two algorithms in a two stages optimization, firstly, according to the data achieved from the parametric analysis the artificial neural network (ANN) is applied, then, in the next stage the artificial bees colony (ABC) is run to optimize the specific network, thermal efficiency and exergy efficiency outputs from ANN. Ongoing, the cycle configuration was not simple either since it had two feedwater heaters, three pumps and a three stages turbine, thus the selected optimization variables were the pumps output pressures for the sake of simplicity. Conclusions present R717 as the fluid with the highest performance.

Roy et al. [30] decided to apply the screening criteria based on the parametric optimization between R-123 (HCFC family) and R-134a (HCF family) for regenerative supercritical ORCs. A Matlab® code was developed to optimize system and second law efficiencies, turbine work output and irreversibility ratio with respect to turbine inlet temperature (TIT) and expansion pressure incrementations under several heat source temperatures. Unlike any previous ORC optimization study, the thermodynamic properties at constant pressures were calculated via MBWR (Modified Benedicte Webbe Rubin) equation of state and standard text [36]. Analysis were carried for fixed heat source temperatures (FHST) as well as for variable heat source temperatures (VHST) in subcritical case. Conclusion were that increasing TIT for R-123 in the range 165-250°C and with pressures between 25-27 bars provides better results for all objective functions, thus resulting in higher efficiencies, turbine work output and lower irreversibility ratios.

The method used by Wang et al. [31] applies a multi-objective parametric optimization, in which two objective functions are weighted by means of coefficients and applied as a single objective function into the annealing algorithm, the first being the heat exchanger area for unit of power output and second the heat recovery. Code was written in MATLAB for the optimization of condensation and evaporation pressures, water cooling velocities and the selection of the fluid from a set of 13 working fluids and WHR temperatures in 100-220°C. The results acknowledged that for WHR temperatures ranging from 100°C to 180°C R-123 is the best choice, however if the exhaust temperatures are over 180°C (up to 220°C) the best suitable fluid is R-141b. Also, they noticed that the objective functions values drop with the growth of pinch point in the evaporator, and the optimal value for this parameter is found to be 15°C. Finally, settled a lower bound for ORC feasibility of 100°C, below that limit ORC technology does not acquire profitable performances.

An ORC cogeneration system driven by various low-temperature geothermal sources was proposed by T. Guo et al. [33]. The analysis was performed among 27 fluids with boiling points ranging $-47.69^{\circ}\text{C} - 47.59^{\circ}\text{C}$, the screening criteria include net power output per unit mass flow rate of hot source, ratio of total heat transfer area to net power output and electricity production cost. The optimization pretends to minimize the ratio of heat transfer area to net power output per unit of mass flow rate of the heat source, while at the same time maximize the latest alone, by means of evaporating temperature. The lowest values of those were found for E170, R600 and R141b. After applying different screening criteria evidences are that optimal evaporating temperatures are $68 - 78^{\circ}\text{C}$ for the entire set of fluids.

Astolfi et al. [34] developed a Matlab® code to identify the best ORC parametric configuration for the exploitation of medium-low temperature geothermal sources ($120-180^{\circ}\text{C}$), including sub and supercritical cycles, convenience of regeneration and thermal reinjection limits.

Fmincon function along with an active set algorithm was elected for the optimization approach, based on the reliability of accuracy and computational time consumption. The parametrization was carried by defining a set of design parameters (pinch points, pressure drops, turbomachinery efficiencies and temperature differences in regenerator and condenser units) to shape the boundaries of the cycle, then, inlet pressure and temperature difference between hot source and the working fluid are optimized for the maximization of plant efficiency, net power output and second law efficiency, as well as an extensive set of working fluids, embracing HFC, FC, Alkanes, Siloxanes and other hydrocarbons.

Conclusions allowed to define some general guidelines for the better combination of variables to achieve the highest efficiencies:

- Optimal efficiencies are found for the fluids that can couple the hot source with ratios of critical temperature to hot source temperature in the arch of $0.88 - 0.92$, and reduced pressure of $1.1 - 1.6$.
- In cases in which the optimal shape is subcritical, superheating represents an inconvenience thus cycles meet optimal values in the saturated region.
- In order not to penalize the recovery rate, regeneration is only considered for those scenarios in which a limit in the reinjection temperature is neglected.
- Leaving economic considerations, a side, supercritical cycles reach higher efficiencies although they entail a higher heat transfer area.
- High complexity fluids are preferable in sets of fluids with similar critical temperature as they lead to better exergetical efficiencies.
- As the heat source temperature is increased, the specific work reaches higher optimal values.

Numerical result can deviate depending on the objective function, nevertheless in all the cases, RC318, C4F10 and R227ea appear as the best fluids from the thermodynamic point of view due to their similar molecular complexity, critical temperature and saturated vapor line shape.

Domenico et al [35] introduced the concept of a hybrid organic Rankine plant, combining a low-grade geothermal source and a solar source, in both, subcritical and supercritical configurations. A multi-objective optimization was conducted to find the higher first and second law efficiencies as well as the lowest levelized energy cost (LEC). The algorithm choice was NSGAI (non-dominated sorting genetic algorithm), while the set variables of variables subjected to optimization are:

- Evaporating and condensing pressures
- Maximum heat source temperature
- Characteristic parameter of temperatures profiles coupling in heat exchangers (e.g. pinch points)

A wide set of 24 fluids was analyzed discretizing by their vapor saturated line shape (i.e. dry, wet and isentropic fluids). Best performing fluids are Cyclopropane, R32 and R143a, whose main differences are due to the hybrid nature of the cycle in which the second law efficiency is inversely proportional to the exploitation of solar energy, therefore, fluids obtaining a relatively high second law efficiency reduce the solar contribution to the minimum and emphasize the geothermal brine exploitation, whilst first law and LEC are directly proportional to dominant solar interference. Cyclopropane achieved the greatest power (100 kW), first law efficiency (9.65%) and lowest LEC (0.114 \$/kWh), however, if the goal is to obtain the highest second law efficiency R143a shortens the solar contribution to achieve a 44% of second law efficiency featuring a power output above 10 kW.

Recent studies have acknowledged the need for more efficient optimization solvers given the non-convex shape of real field problems, which promote the existence of multiple undesirable local solutions. In contrast, deterministic global optimizers guarantee the best attainable non-suboptimal solutions within a given tolerance. Wolfgang et al. [37] studied this phenomenon choosing the following optimization variables: condensation and evaporation pressures, mass flow rate of working fluid and the degree of recuperation (if applicable). The solution was enabled by the automatic propagation of McCormick relaxations [38] in a Branch-and-Bound (B&B) algorithm [39] to create convex relaxations of the optimization problem that allow the reduction of the number of variables seen by the optimizer, hence decreasing the computational time. The carried study case focused on a geothermal heat source for which identical analysis were conducted in order to demonstrate the prevalence of deterministic global solvers and sequential-modular formulation over equation-oriented local solvers. In fact, local solvers converged to suboptimal solutions up to 20% of trials (if not failed convergence). Final simulation occurred under three different scenarios of attainable cooling water (-5°C, 0°C and 15°C) and showed that for work output maximization the best variables are condensation and evaporating pressures of 2.44 and 15.9 bars respectively, leading to 28.4 MW.

Also, the latest studies show how the optimization of ORC is leading to find the best suitable combination of cycle design with a special emphasis on zeotropic organic mixtures, J. Schilling et al. [43] present a method to rigorously analyze the potential of optimal mixtures in comparison to pure fluids applied to ORC based on the well known advantage of mixtures regarding the process efficiency due to their favorable temperature-glide during evaporation and condensation. These increasing interest for mixtures applied for ORC supports the goals and curiosity of the present work which was initiated back in 2018 with incredible delightment.

After this ORC optimization anthology, all the studies agreed the combinations of working fluid and the diverse cycle parameters have a crucial impact on the efficiency of the cycle, the size of the components and the overall economic feasibility. Nevertheless, Scaccabarozzi et al. [18] pointed the necessity for more systematic studies to embrace optimization of the fluid, integration of heat and sink sources and the specific thermodynamic performance (i.e. variables at each point of the cycle). Thus, an extensive analysis and verification is made concerning this issue, in which the selection of the fluid is divided between pure organic fluids and binary zeotropic mixtures of organic fluids.

2 SYSTEM MODELING

This chapter aims to present the modelation approach to ORC cycles including all possible configurations with regard to Subcritical-Supercritical, regeneration, thermodynamic process, heat and sink sources and how all the parameters have been brought together to compound a feasible optimization tool.

2.1 Model description

As it has been reviewed, most of the studies focus on the optimization of specific configurations (e.g. only subcritical conditions), fluids and applications (geothermal and WHR for a clear majority) which limit the possibility of finding better solutions. In contrast, this work considers a wide range of heat sources, aiming to cover most medium-low grade profiles available. Screening criteria is applied for each individual heat source, targeting the temperature limits imposed by REFPROP. Moreover, except for few works, most of the previous studies seem to lack the implementation of losses in the static modeling. Also, the application of regeneration remains still uncertain with a strong dependency on the fluid and the heat-sink sources. Fig 2. shows the standard layout of an ORC (a) along with layout of a regenerated ORC (b).

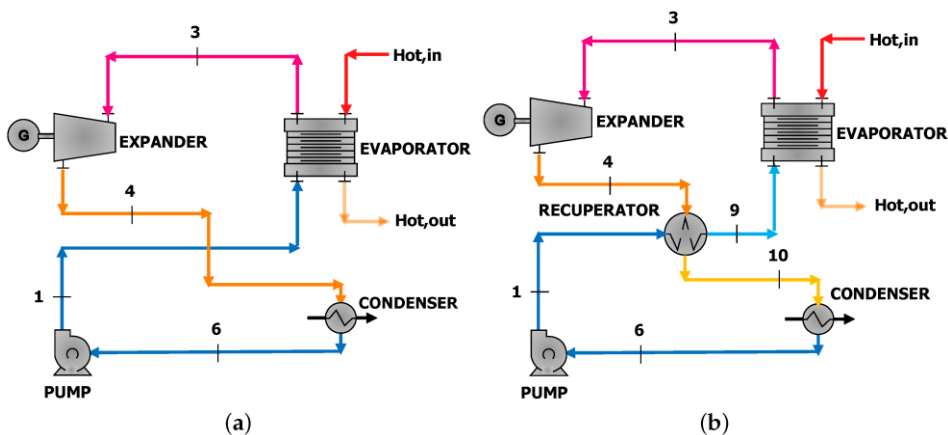

Figure 2. Standard layout of an basic ORC cycle (a) and regenerated ORC (b).

Therefore, this work aims to unify the optimization of a diverse variety of configurations, allowing sub/supercritical, recuperative/non-recuperative, degree of superheating or even wet expansion start, all accounting on pressure losses for both pure fluids and zeotropic mixtures in order to cover a wide range of potential scenarios and applications.

For that, the power plant layout shown in Fig. 3 describes the cycle with the distribution of twelve points in a) subcritical and b) supercritical cases. Acknowledge how points 4,5 and 6 merge into the same state for supercritical configurations. The calculation of this point plays a crucial role in how the code is designed.

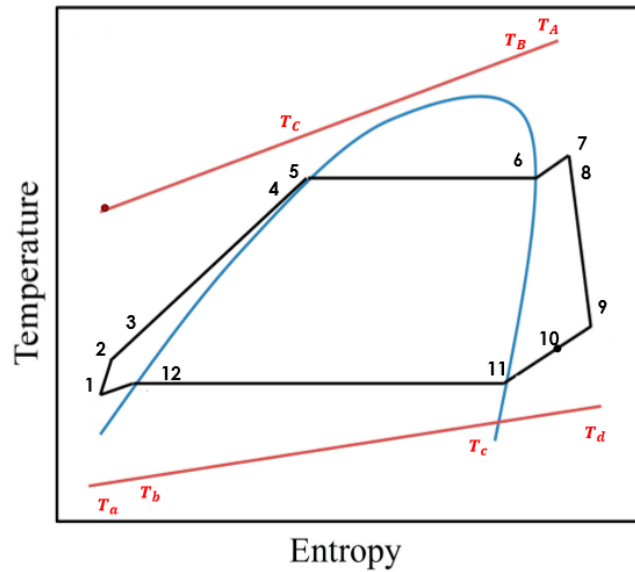

Figure 3 a). Subcritical Temperature-Entropy layout diagram.

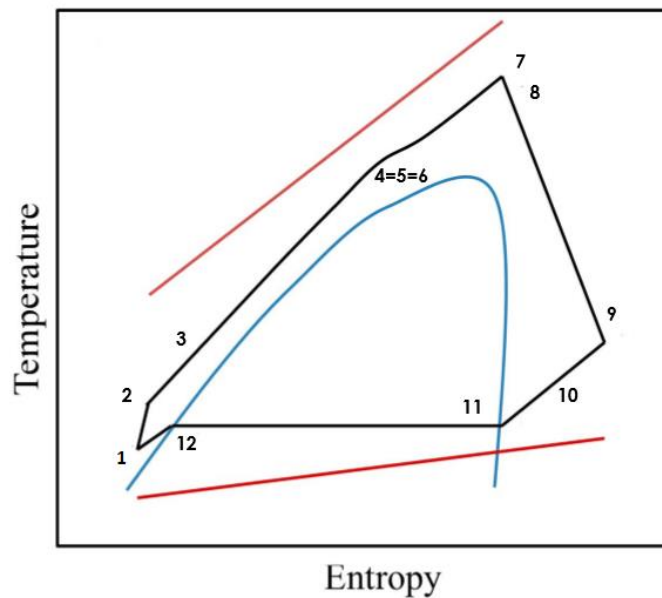

Figure 3 b). Supercritical Temperature-Entropy layout diagram.

The thermodynamic process starts at point number one (P1) where the fluid is subcooled at the condenser outlet, then compressed into the pump to reach point two (P2) which has the highest pressure of the cycle. After that it enters in the high-pressure side of the regenerator (P3, if convenient) before getting into the primary heat exchanger (PHE), which is divided into three stages (i.e economizer, evaporator and superheater) to distinguish the phases of heat absorption. Economizer outlet is P4, evaporator inlet and outlet are points P5 and P6 respectively and superheater outlet (if applied) is represented by P7.

However, this are the subdivisions of the PHE only if the study case is under subcritical conditions, otherwise, when under supercritical scenarios no heating discretization is considered since the fluid does not go through a two-phase transition. Following, from P7 to P8 the fluid goes across the expansion valve used to regulate the expansion conditions. P8 represents the beginning of the expansion process which finishes at P9, from then it enters the low-pressure side of the regenerator in the cases that its use is desirable to achieve P10. Finally, to close the cycle the fluid undergoes a desuperheating process until saturated vapor conditions (P11) to finish condensing into saturation liquid (P12).

Concerning the fluid selection criteria, a screening method has been used focusing on an environmental point of view, meaning that fluids with high GWP or ODP are neglected although the code is capable of computing solutions if necessary. Additionally, when conducting optimization, the thermostability of the potential fluids is taken into consideration. Therefore, those fluids whose thermal limit is below the heat source temperature are discarded.

2.2 Model INPUTS

For the optimization of a specific ORC application, the code developed in this work needs several inputs that will represent the cycle parameters. These are shown in **Table 1.** and are taken from Astolfi et al. [34] and data based in literature primarily. However, further research has shown slight improvements implementing values from Wei et al. [23], Wang et al. [31], Scaccabarozzi et al. [40] and real power plants data sheets.

TABLE 1. CONFIGURATION PARAMETERS

| Design paramters | Optimal values |
|------------------------|----------------|
| $\Delta T_{pp,PHE}$ | 3 °C |
| $\Delta T_{pp,rec}$ | 5 °C |
| $\Delta T_{ap,cond}$ | 15 °C |
| $\Delta T_{ap,cond}^*$ | 0.5 °C |
| $\Delta T_{sc,cond}$ | 1 °C |
| $\Delta T_{sc,evap}$ | 1 °C |

The intention of the current code is to further be implemented with specific models for each component of the cycle (i.e. turbine, pump and heat exchangers), so that it serves as a basis for future works to make it more complex and precise. For this reason, it is written in a sequential-modular way allowing easy implementation. Nonetheless, the actual state considers fixed values in representation of each component performance in the form of efficiencies, **Table 2.**

In addition, since it has been noticed a growing interest from manufacturers in simulating wet expansions, the optimization considers the possibility of starting expansion in the wet zone if the algorithm converges towards this region, although there is a minimum vapor quality that cannot be lowered as it has been acknowledged in Scaccabarozzi et al. [40].

TABLE 2. EFFICIENCY OF EQUIPMENT AND VAPOR QUALITY

| Efficiency | Design values |
|------------------------|---------------|
| $\eta_{is,turb}$ | 85% |
| $\eta_{is,pump}$ | 70% |
| $\eta_{mec-elec,turb}$ | 95% |
| $\eta_{mec-elec,pump}$ | 95% |
| $\eta_{gear\ box}$ | 97% |
| vq_{min} | 88% |

Although there are several design parameters, losses coefficients and efficiencies depend on the equipment choice (technology, quality and maintenance) therefore not strictly relevant for the case of cycle design optimization, meaning that the intersecting parameters for this purpose are the so called “Cycle defining parameters” which are shown in **Table 3**.

TABLE 2. CYCLE DEFINING PARAMETERS

| Paramter | Definition |
|------------------------|--|
| $P_{in,turb}$ | Inlet turbine pressure |
| $\Delta T_{ap,PHE}$ | Approach temperature difference at PHE |
| $\Delta T_{pp,PHE}$ | Pinch point temperature difference at PHE |
| $\Delta T_{ap,cond}$ | Approach temperature difference at condenser |
| $\Delta T_{pp,cond}^*$ | Modified pinch point difference at condenser |
| $\Delta T_{pp,rec}$ | Pinch point difference at recuperator |

It is important to mention that, whilst the present work focuses on the optimization of $P_{in,turb}$ and $\Delta T_{ap,PHE}$ in order to optimize the objective function which is the plant efficiency, the developed code is flexible to optimize any other combination of two of the cycle defining parameters. In that case $P_{in,turb}$ and $\Delta T_{ap,PHE}$ will have to be a fixed value.

Fig 4. Shows the mentioned Design Parameters in the corresponding subcritical (a) and supercritical (b) T-s diagram.

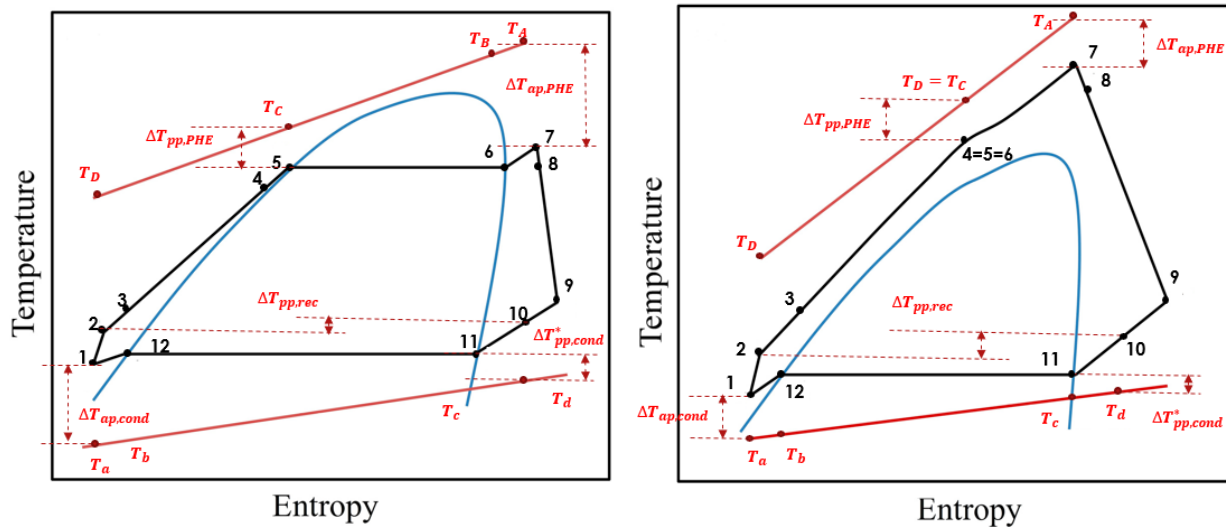

Figure 4 a). Design parameters in subcritical T-s. **Figure 4 b).** Design parameters in subcritical T-s diagram.

Concerning heat exchangers it is convenient to mention that there is a minimum pinch point temperature required during heat exchanges between fluids, this is because there is a crucial necessity to avoid the mathematical solutions in which the working fluid reaches a temperature higher than the hot source at any isentropic state. For this study the corresponding minimum pinch point differences for the primary heat exchanger and the recuperator (if applied) are taken from various literature and shown in previous **Table 1**.

2.3 Thermodynamic model

In this section the thermodynamic model is presented. Once all the design parameters are fixed the thermodynamic properties at each point are computed with REFPROP® data base in a sequential-modular way by following the well-known laws of thermodynamics. Given the fact that the present work considers optimization of subcritical and transcritical configurations accounting on losses all along the cycle, the code computes a parallel algorithm to account on both scenarios. Fig 5. shows the different flow charts followed by the algorithm depending on the configuration.

Appropriate attention is required for mixtures thermodynamic modeling. Particularly, behavior of mixtures, especially during non-isothermal phase transition, suggest promising results since the glide matching between temperature profiles in condenser and evaporator is remarkably higher. Herbele et al. [42] studied this phenomenon in the application of ORCs and proved that usage of binary zeotropic mixtures leads to higher efficiencies than pure fluids because of the reduction regarding irreversibility caused by the better temperature matching in heat exchanger equipment. Fig 5.

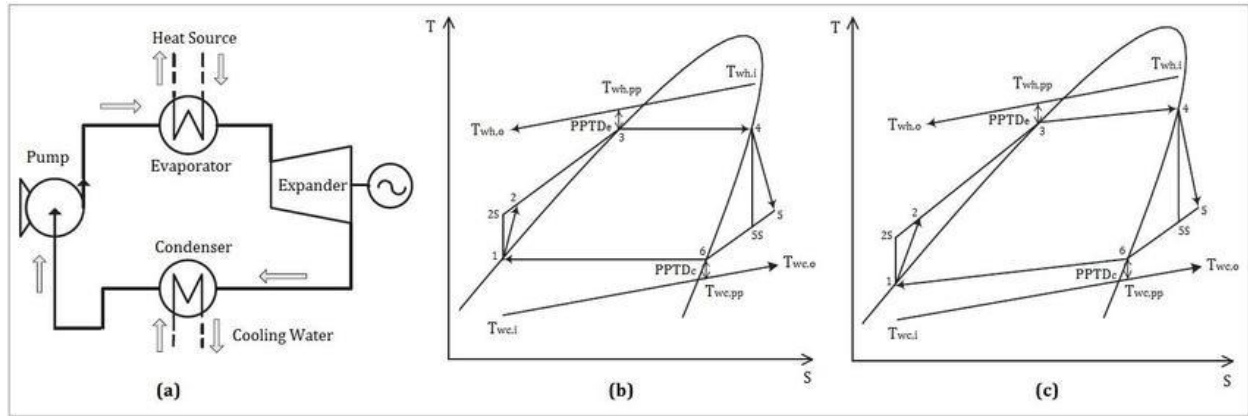

Figure 5. T-s diagram differences between pure fluids and mixtures.

Nonetheless, the aim of this work is to accomplish the optimization of binary mixtures composition in terms of molar fractions. For a given set of pure fluids the code returns the best binary combination among them as well as the corresponding optimal molar fractions with respect to the objective function, that can either be the net work output Eq. (1), plant efficiency Eq. (5) or second law efficiency Eq. (7) (accounting on reinjection limits if applied).

$$\dot{W}_{net} = \dot{m}_{WF} * (\Delta h_{turb} - \Delta h_{pump}) \quad (1)$$

$$\dot{Q}_{in} = \dot{m}_{HS} * \Delta h_{PHE} \quad (2)$$

$$\eta_{cycle} = \frac{\dot{W}_{net}}{\dot{Q}_{in}} \quad (3)$$

$$\varepsilon_{rec} = \frac{\dot{Q}_{in}}{Q_{in,max}} \quad (4)$$

$$\eta_{plant} = \eta_{cycle} \eta_{rec} = \frac{W_{net}}{Q_{in,max}} \quad (5)$$

$$\eta_{CARNOT} = 1 - \frac{T_{amb}}{T_{HS,in} - T_{HS,out-lim}} \frac{1}{\ln\left(\frac{T_{HS,in}}{T_{HS,out-lim}}\right)} \quad (6)$$

$$\eta_{II} = \frac{\eta_{plant}}{\eta_{CARNOT}} \quad (7)$$

In contrast to a vast majority of previous studies, the mass flow of the working fluid is not a required input, in fact the code produces the mass flow ratios of hot source to working fluid and cold sink to working fluid as outputs, thus none of the mass flows affect the optimization results (i.e. working fluid, heat source or cold sink mass flows). Whilst its obtainment is trivial for subcritical configurations (a simple energy balance in condenser and evaporator will lead to the respective mass flow ratios), if the optimal converges towards a transcritical cycle the calculation of the hot source to working fluid mass flow ratio (i.e. m_{HS-WF}) becomes non-trivial. Since in supercritical cycles the fluid's heat absorption does not undergo phase change, the pinch point is not located in the saturated liquid curve at evaporating pressure as in subcriticals.

In order to solve this problem, it is necessary to discretize the supercritical heat absorption in several steps and compute energy balance differentials to locate the pinch point (i.e. pinch point function).

Additionally, the fact that mass flow ratios are output parameters that do not affect the optimal results brings the opportunity to achieve higher efficiencies in comparison to fixed flow analysis. Even if the potential heat source has a limited flow or the working fluid availability is low the present work converges to an optimal for such scenario.

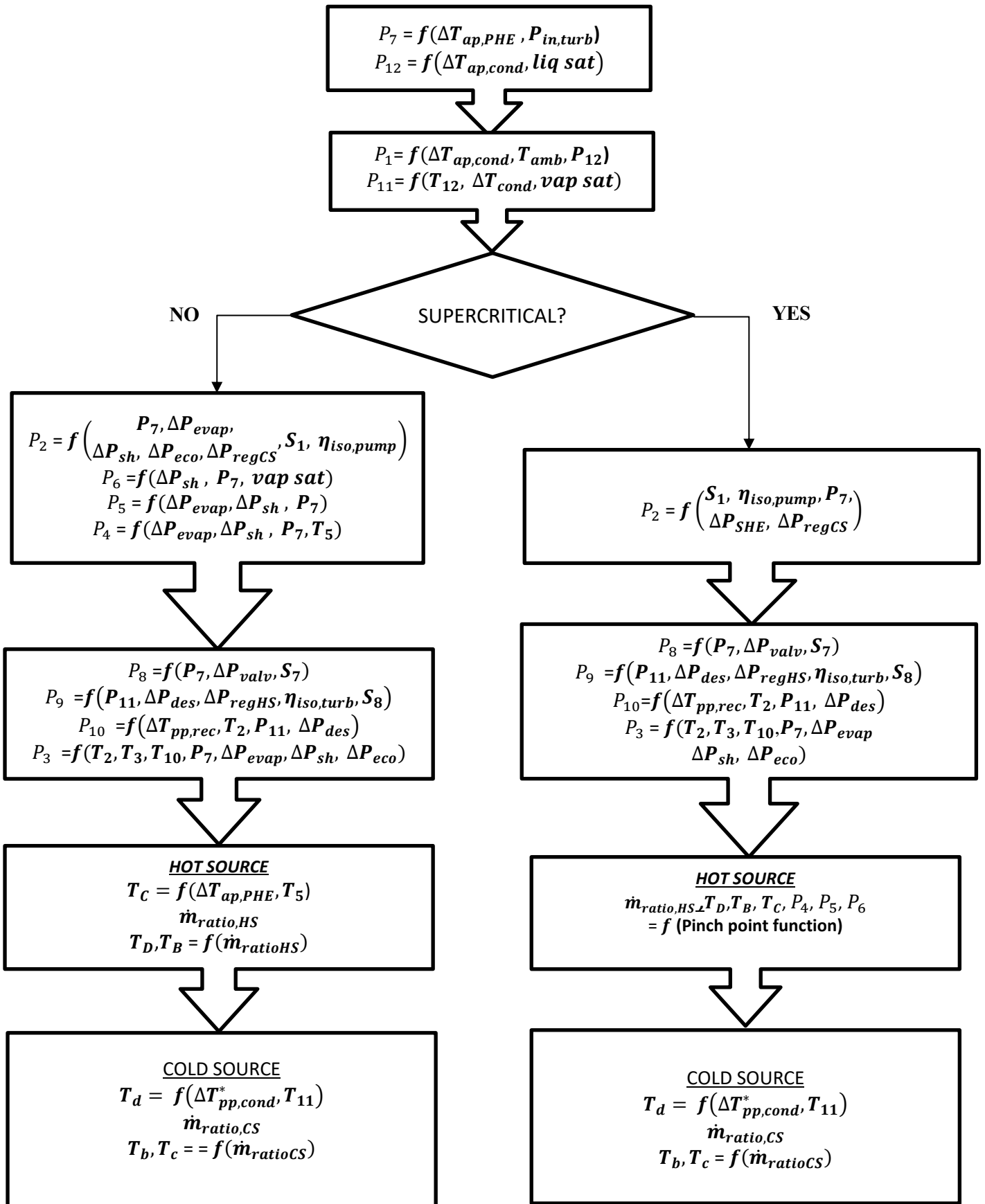

Figure 6. Flow chart of thermodynamic algorithm.

2.4 Model OUTPUTS

As a result of the optimization algorithm there are several outcomes produced by code to define the optimal solution and to facilitate the analysis of key points of the resulting optimal cycle. These Outputs are the following.

2.4.1 Optimal expansion pressure $P_{in,turb}$ and temperature difference between heat source and expansion temperature $\Delta T_{ap,PHE}$.

According to several studies published in literature (Dai Y et al. [11], Schuster A et al. [28]), these two parameters are proven to be among the most interesting and useful variables to optimize along literature due to the fact that they have a strong impact on the net work output obtained from the turbine, thus there is a relevant interest in optimizing this for a given fluid.

2.4.2 Best performing fluid among the given selection.

The code is fed up with a list of organic fluids the user is interested in analyzing (input), then it executes the optimization for all of them and results in the best performing fluid among the inlet users list. Exhaustive criteria is strongly recommended in order to decrease computational time, moreover similar complexity of fluids contributes to a potential mixture analysis resulting in a feasible fluid.

2.4.3 Best mixture between the given pure fluids and its optimal composition.

If a mixture is taken into account as working fluid, the code looks for the best binary combination pairing the given list of pure fluids and result in the best binary mixture and its molar fractions in order to obtain the best suitable performance for the given parametrization.

2.4.4 Mass flow ratios of working fluid with respect to heat and cold sinks.

As previously mentioned, the mass flow ratios are an output computed by the code depending on the optimal result for the desired optimization function. Since there is no need to provide this as inputs to run the code the adaptability to the range of solutions is higher.

2.4.5 T-s diagram of entire cycle along with evolution of heat and cold temperature profiles.

Fig 7 a) and b) show the output T-s diagram for both subcritical and supercritical configurations, along with the evolution of compressibility and saturation curve for optimal solution. Furthermore, for the case of supercritical configurations Fig 8. Shows a close up look to the pinch point as its location and calculation is not trivial.

2.4.6 Excel summary file with all data results.

The Excel file contains the following sheets:

- Cycle parameters (mass flow ratios, configuration of cycle, pressure in condenser etc.)
- Thermodynamic states of 12 points of model (Temperature, Pressure, Entropy, Enthalpy)
- Hot source fluid and temperature evolution profile
- Cold sink fluid and temperature evolution profile

- Turbine performance (model efficiency and specific work output)
- Pump performance (model efficiency and specific work output)

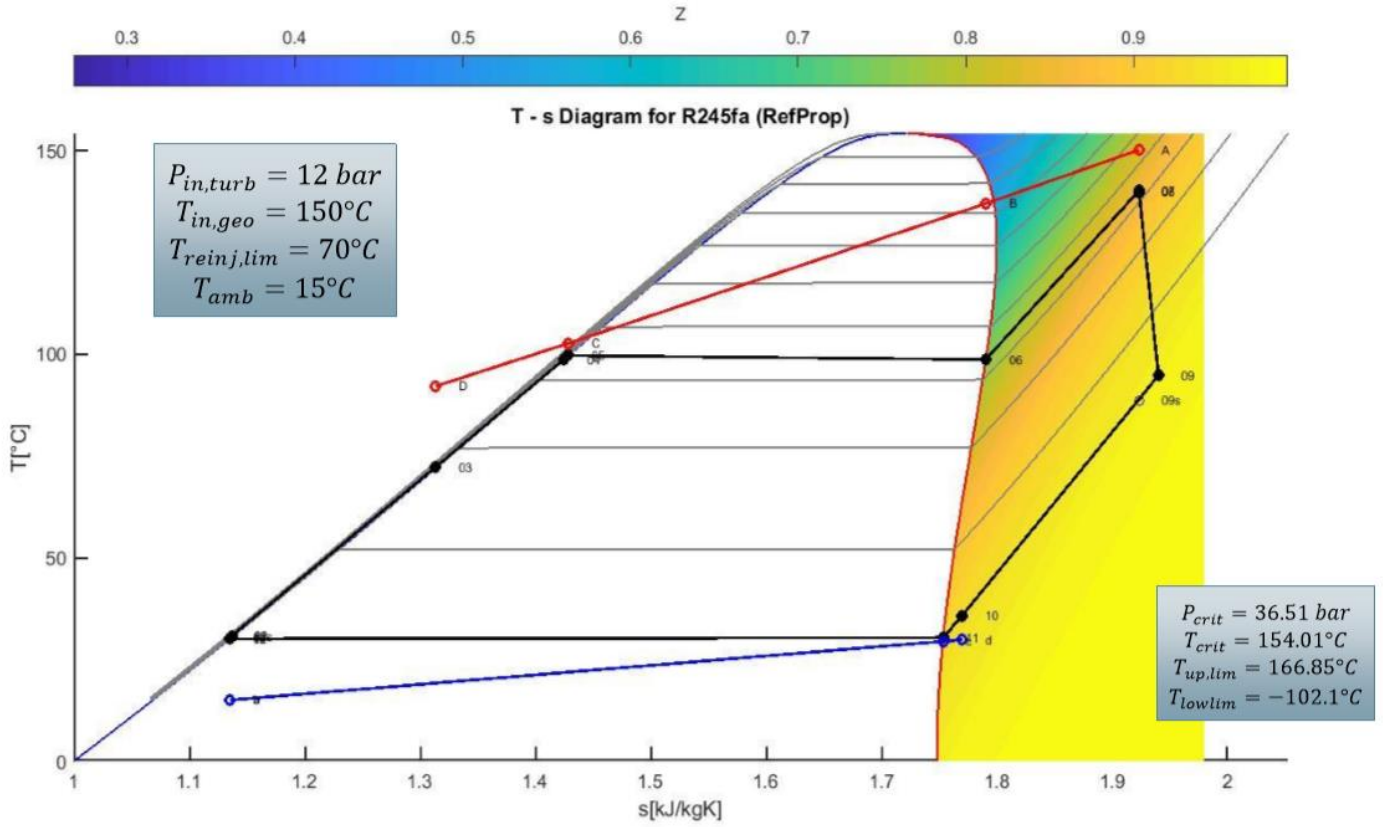

Figure 7 a). Temperature-Entropy diagram for a subcritical analysis of R245FA.

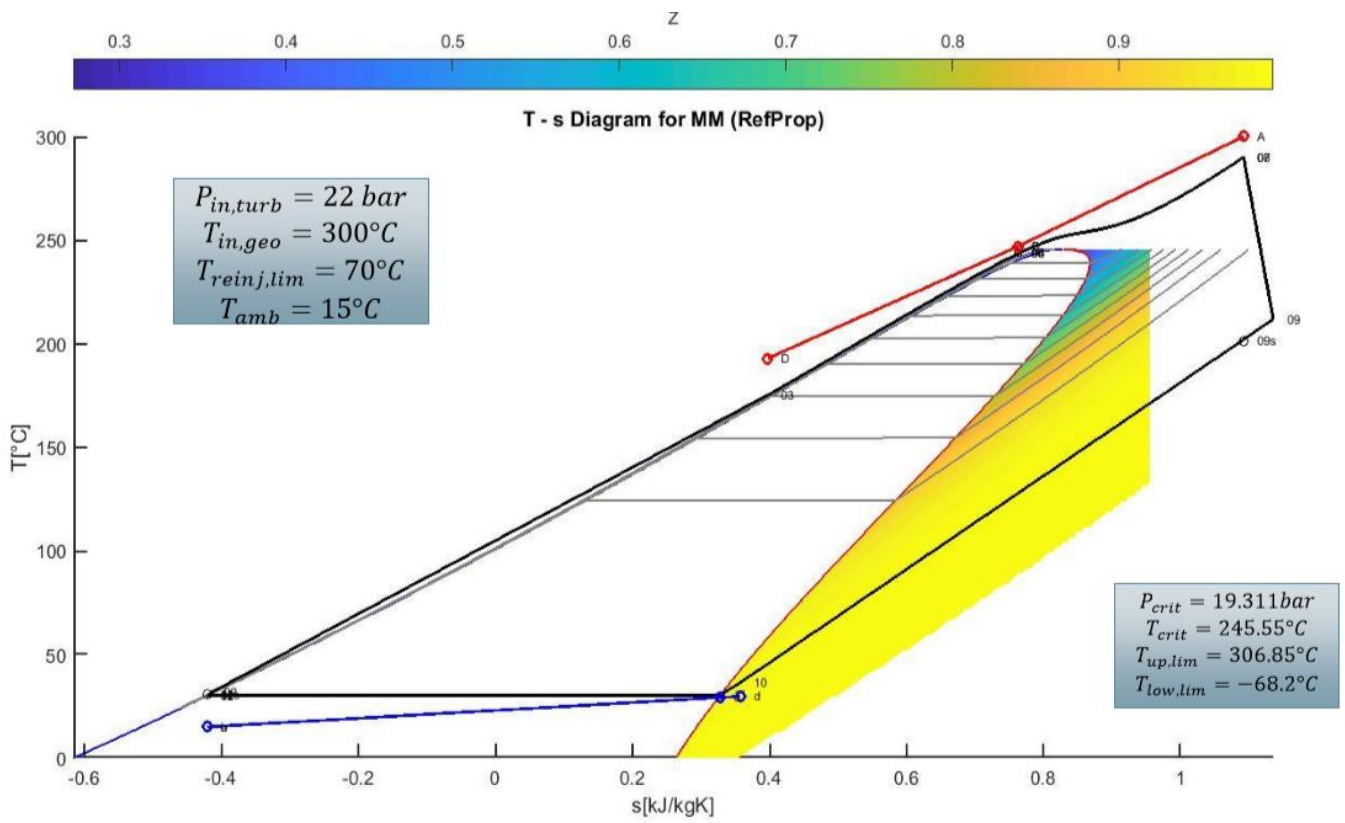

Figure 7 b). Temperature-Entropy diagram for a supercritical analysis of MM.

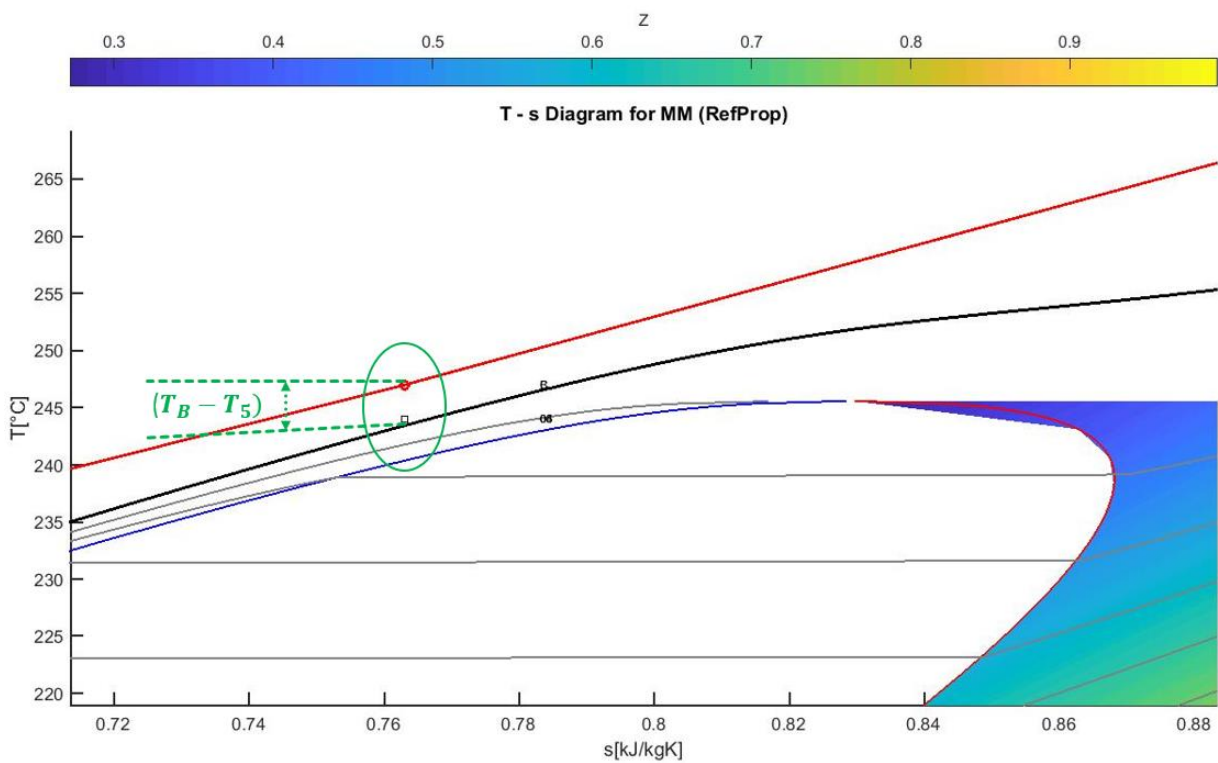

Figure 8. Close up view to pinch point location in supercritical cycle of MM.

2.4.7 T – Q Diagram of hot source and cold sink.

For a comprehensive description of solution, the code produces T-Q diagrams for both, heat source and cold sink, for a better analysis of heat transfer. Fig 9 a) , b) , c) and d) show this for any configuration.

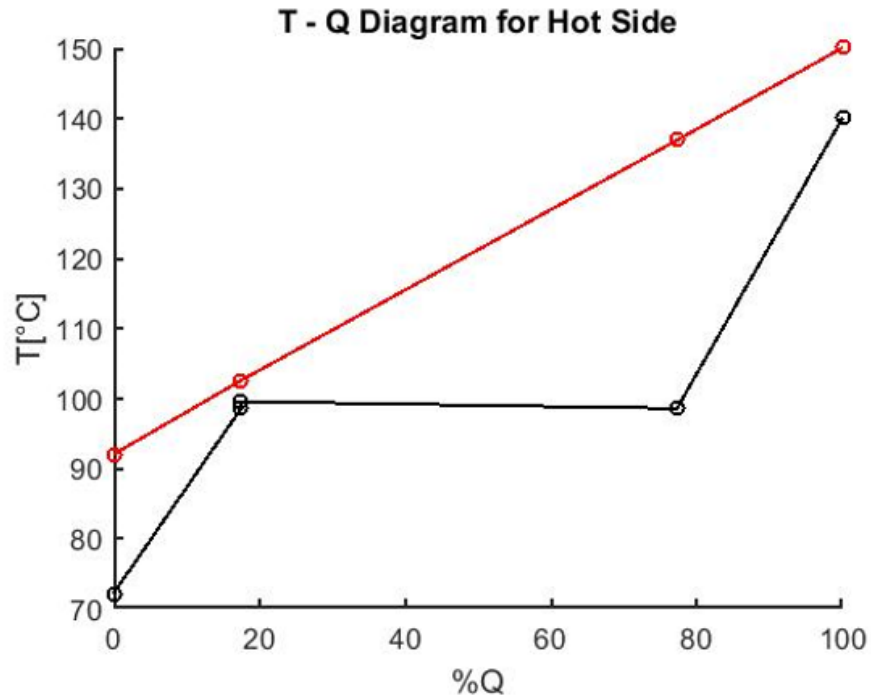

Figure 9 a). T-Q diagram for hot source under Subcritical conditions.

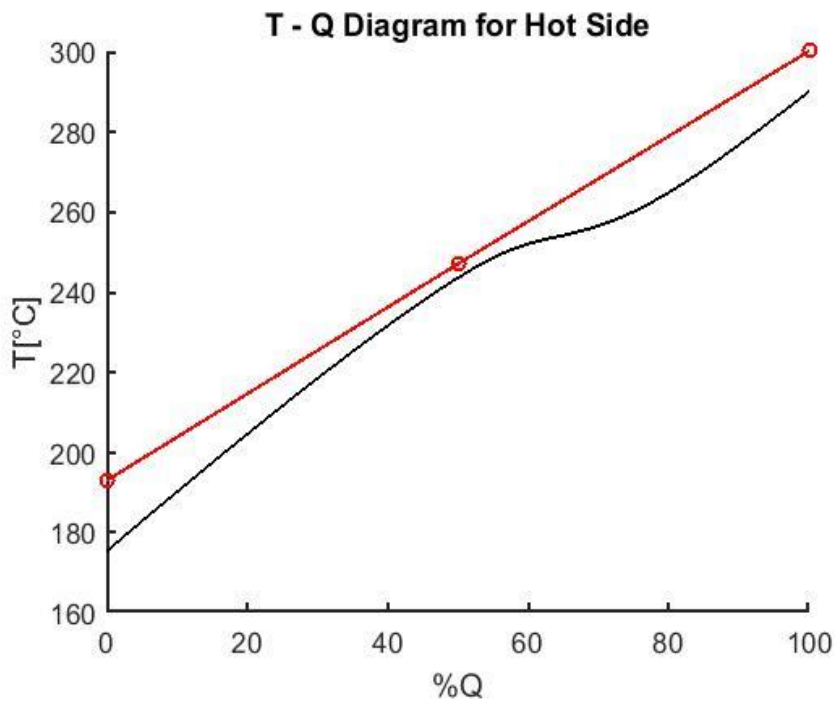

Figure 9 b). T-Q diagram for hot source under Supercritical conditions.

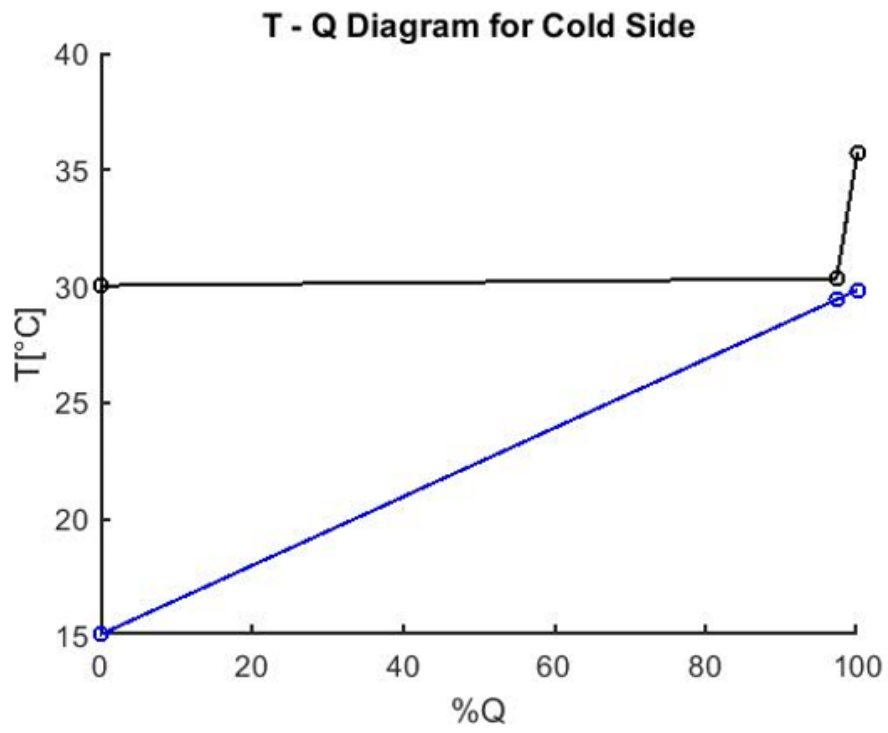

Figure 9 c). T-Q diagram for cold sink.

2.4.8 T – Q Diagram of regenerator.

Regeneration is an optional parameter, which has special impact for subcritical models. The code produces a T-Q diagram to analyze the effect of heat transfer and its effectivity in the cycle. Fig 10 shows an example,

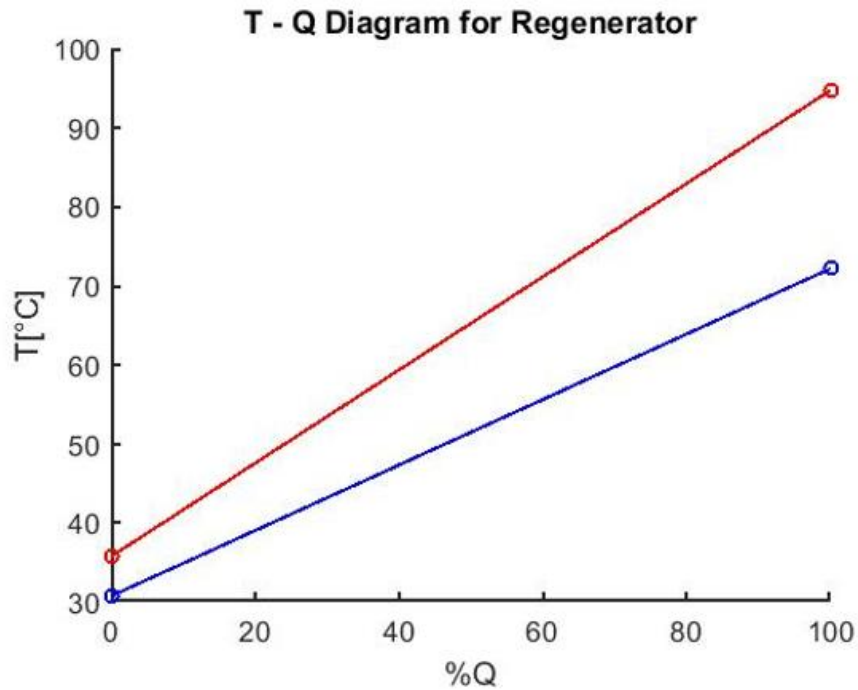

Figure 10. T-Q diagram for regenerator.

| | A | B | C | D | E |
|----|--------------|-------------|-------------|-------------|-------------|
| 1 | fluid | cycle_pts | | | |
| 2 | R245fa | | | | |
| 3 | | | | | |
| 4 | cycle_points | T | P | h | s |
| 5 | pt_01 | 30 | 1.777850975 | 239.102901 | 1.135454996 |
| 6 | pt_02 | 30.70520406 | 13.52149075 | 240.3678813 | 1.136704513 |
| 7 | pt_02s | 30.41988 | 13.52149075 | 239.9883872 | 1.135454996 |
| 8 | pt_03 | 72.14082628 | 13.02149075 | 297.6998094 | 1.31354713 |
| 9 | pt_04 | 98.55641948 | 12.52149075 | 337.5016883 | 1.424682695 |
| 10 | pt_05 | 99.55641948 | 12.52149075 | 339.0853808 | 1.42893757 |
| 11 | pt_06 | 98.55641948 | 12.24489796 | 473.4156841 | 1.790399147 |
| 12 | pt_07 | 140 | 12 | 525.0269984 | 1.923204313 |
| 13 | pt_08 | 139.6755388 | 11.88 | 524.8050583 | 1.923204313 |
| 14 | pt_09 | 94.67679458 | 1.852121703 | 489.7519938 | 1.940163317 |
| 15 | pt_09s | 88.53704175 | 1.852121703 | 483.5661589 | 1.923204313 |
| 16 | pt_10 | 35.70520406 | 1.815079269 | 431.8409553 | 1.7698753 |
| 17 | pt_11 | 30.3 | 1.796928477 | 426.651392 | 1.753504915 |
| 18 | pt_12 | 30 | 1.777850975 | 239.102901 | 1.135454996 |
| 19 | | | | | |

Figure 11. Output Excel file with thermodynamic states of all cycle points.

3 OPTIMIZATION METHOD

This chapter intends to describe the mathematical tool chosen for the algorithm optimization. Despite the understimation of previous studies, this work analyzes the different types of existing optimization algorithms, making emphasis on the mathematical basis of them and concluding that heuristic non-deterministic algorithms are much more convenient than regular non-descendant algorithms.

3.1 Mathematical algorithm.

After several considerations, the final mathematical method selected has been the Genetic Algorithm (GA), the most important reasons for this choice are its adaptability to converge when objective functions have discontinuities, nondifferentiable or highly nonlinear and its stochastic nature inspired in natural selection process. Although its performance has proven to be the best among all the considered algorithms, like Fmincon tool from MatLab (Gradient-Descendant) or Annealing (Heuristic), it is important to mention that it still lacks a strong dependency on algorithm parameters and initial range values.

The way GA works is understanding iterations as generations with different gens, and solutions as children, thus the results at each iteration. Starts with an initial random population and at every generation the algorithm uses the current population to create the children that make up the next generation, this by selecting groups of individuals in the current population called “parents” (previous generation children) for the next generation which pass on their gens (variable values) by stochastic process.

In order to define the next generation population, the GA produces three types of children from the current population:

- Elite: These are the individuals producing the best value towards termination criteria, they automatically survive to the next generation.
- Crossover: They appear as a stochastic combination of vectors from feasible parents.
- Mutation: Created by introducing random changes to a single feasible parent.

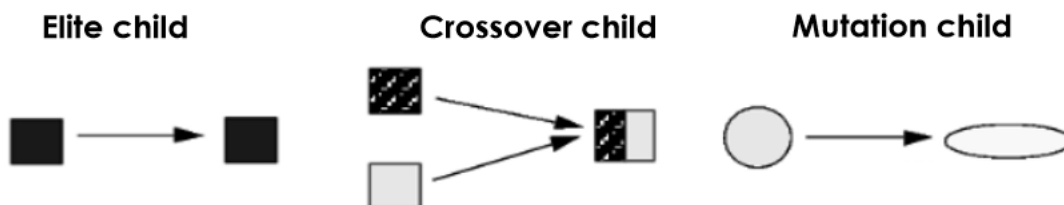

Figure 12. Types of children in Genetic Algorithm.

As a result, at each iteration there will be some gens improving the result of objective function towards termination criteria, these gens are promoted by algorithm while still considering random phenomena in order to converge to a solution.

It has been repeatedly mentioned that the developed code is able to compute both pure fluid and zeotropic mixture analysis, depending on this the optimization variables are the following:

- If pure fluid analysis: $P_{in,turb}$, $\Delta T_{ap,PHE}$ and working fluid (best among provided list)
- If mixture analysis: $P_{in,turb}$, $\Delta T_{ap,PHE}$, best binary mixture and its molar fractions

When optimizing for mixtures it is convenient to apply screening criteria and select organic fluids from the same family (alakanes, HFC, siloxanes...)

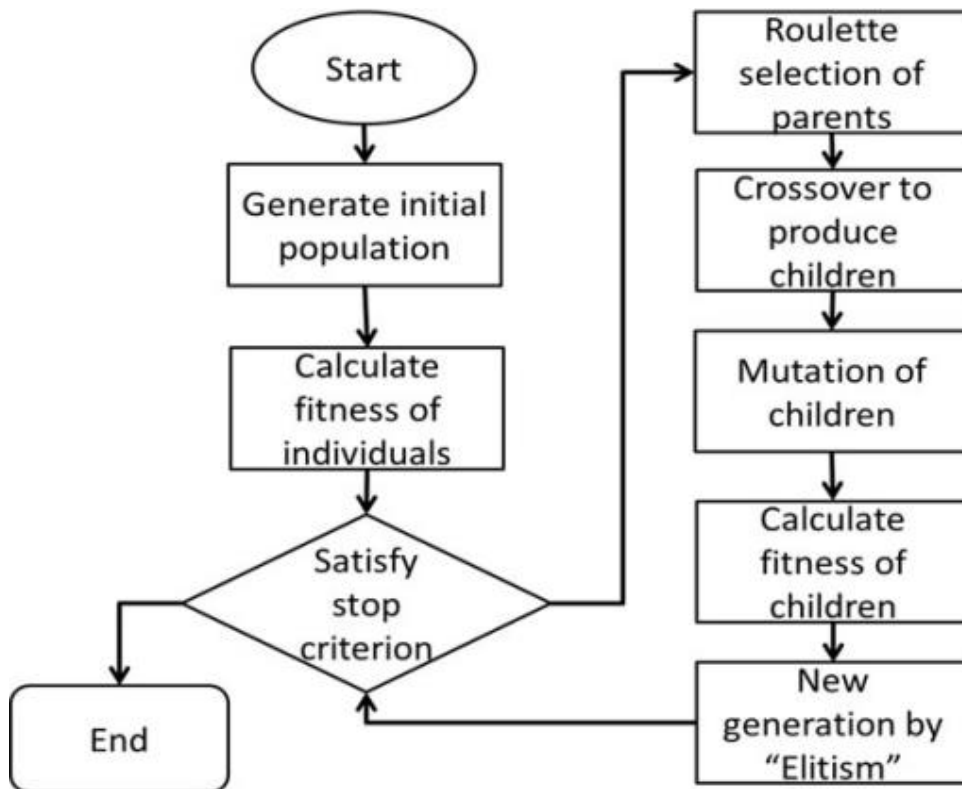

Figure 13. Flow chart of genetic algorithm.

3.2 Optimization modeling.

3.2.1 Objective function.

As previously mentioned in the thermodynamic model description, the primary objective function is the plant efficiency which is based on the cycle efficiency taking into consideration the potential regeneration.

$$\eta_{plant} = \eta_{cycle} \eta_{rec} = \frac{W_{net}}{Q_{in,max}} \quad (5)$$

Nonetheless this another parametrized aspect in the code and although this parameter is well known to be among the most interesting to optimize it can be changed for other like work output W_{net} or heat absorption Q_{in} .

3.2.2 Penalization functions.

As the code and the specified optimization algorithm (GA) are both strict mathematical tools, the optimization results can theoretically converge into non-feasible thermodynamic solutions like wet expansion, thermal instability etc. In order to avoid falling into these unfeasible results it is crucial to define a set of penalization functions preventing each undesired phenomenon from happening. Fig 11 shows an example of unacceptable performance of the code.

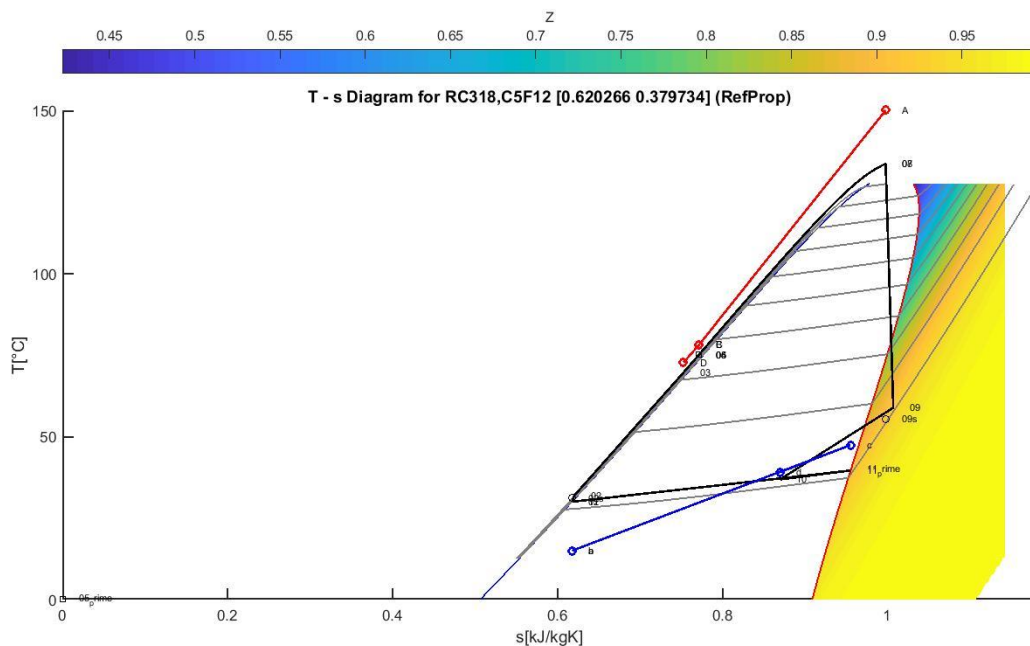

Figure 14. Unfeasible results: Supercritical shape with wet expansion.

The approach of this problem brings one again the need of defining a mathematical shape for the implementation of penalization in the code, as the penalization aims to discard certain scenarios as soon as possible it is clear that mathematical shape needs a exponential form, thus the following formulation is chosen for its proven robust performance and smooth convergence.

$$y = \lambda * (x)^k \quad (8)$$

Where:

λ = constant to determine the level of penalization (100-1000)

x = phenomena to penalize

k = constant exponent ($k - 1$ continuous derivatives)

Once the mathematical shape of penalization considerations has been defined, is necessary to mention the specific phenomena that need to be avoided and its formal representation in code.

3.2.2.1 Thermal stability

The first penalization function discards solutions for which the REFPROP limits are exceeded (i.e. termal stability).

$$y = \lambda * (T_7 - T_{limit})^k \quad (9)$$

Where T_7 the temperature at the turbine inlet and T_{limit} the limit for REFPROP accuracy.

3.2.2.2 ReInjection limit

For configurations with a reInjection limit in the hot source, there is penalization to avoid exhaust temperatures below the limit.

$$y = \lambda * (T_{reInjection\ limit} - T_D)^k \quad (10)$$

Where T_D is the reInjection result for the hot source.

3.2.2.3 Dry end of expansion process.

In order to guarantee dry end of expansion

$$y = \lambda * (1 - q_9)^k \quad (11)$$

Where q_9 is the vapor quality of the working fluid at the end the expansion.

3.2.2.4 Guarantee dry expansion in supercritical.

$$y = \lambda * \left(\sum_{i=1}^n q_i \right)^k \quad (12)$$

Where q_i is the vapor quality at each differentiation of heat absorption.

3.2.2.5 Avoid subcooled start.

$$y = \lambda * (T_{evaporation} - T_7)^k \quad (13)$$

Where $T_{evaporation}$ is the evaporation temperature of the working fluid.

3.2.2.6 Guarantee minimum vapor quality.

$$y = \lambda * (\min_q - q_7)^k \quad (14)$$

3.2.2.7 Overlapping.

Given the consideration of losses, overlapping of configurations can occur and it is strongly necessary to avoid

$$y = \lambda * (P_2 - P_{critical})^k \quad (15)$$

Where $P_{critical}$ is the critical pressure of the working fluid.

3.2.3 Working fluid optimization.

The pure fluid optimization is performed by running the algorithm for every single fluid and choosing the one providing the best result towards termination criteria among all of them, however, this work aims to give further computational support to the theory of mixtures.

For this purpose, the initial code for pure fluids optimization has been verified in first place (see verification section) to be later modified in order to include the optimization of binary mixtures also.

This adds new problems with regards to the algorithm and thermodynamic state calculation, in one hand brings a new variable which is the molar concentrations of binary mixture and the other hand being the data base approach for thermodynamic states of mixture.

The resolution of the first one is another reason to enhance the Genetic Algorithm as most suitable method given its multi objective nature, thus including a new variable will only increment the computational time but it won't affect the capability of finding a global optimal. Meanwhile, REFPROP data base can calculate the mixtures properties by applying mixture rules to the pure-fluid Helmholtz energies.

Thus, in analog way to how the pure fluids are optimized, the binary zeotropic mixtures run the identical model with the difference on the data base calculation, which in this case takes into consideration the molar fractions of each component to determine the properties of resulting mixture. Fig 12 shows output T-s diagram of mixture optimization with the optimal molar composition.

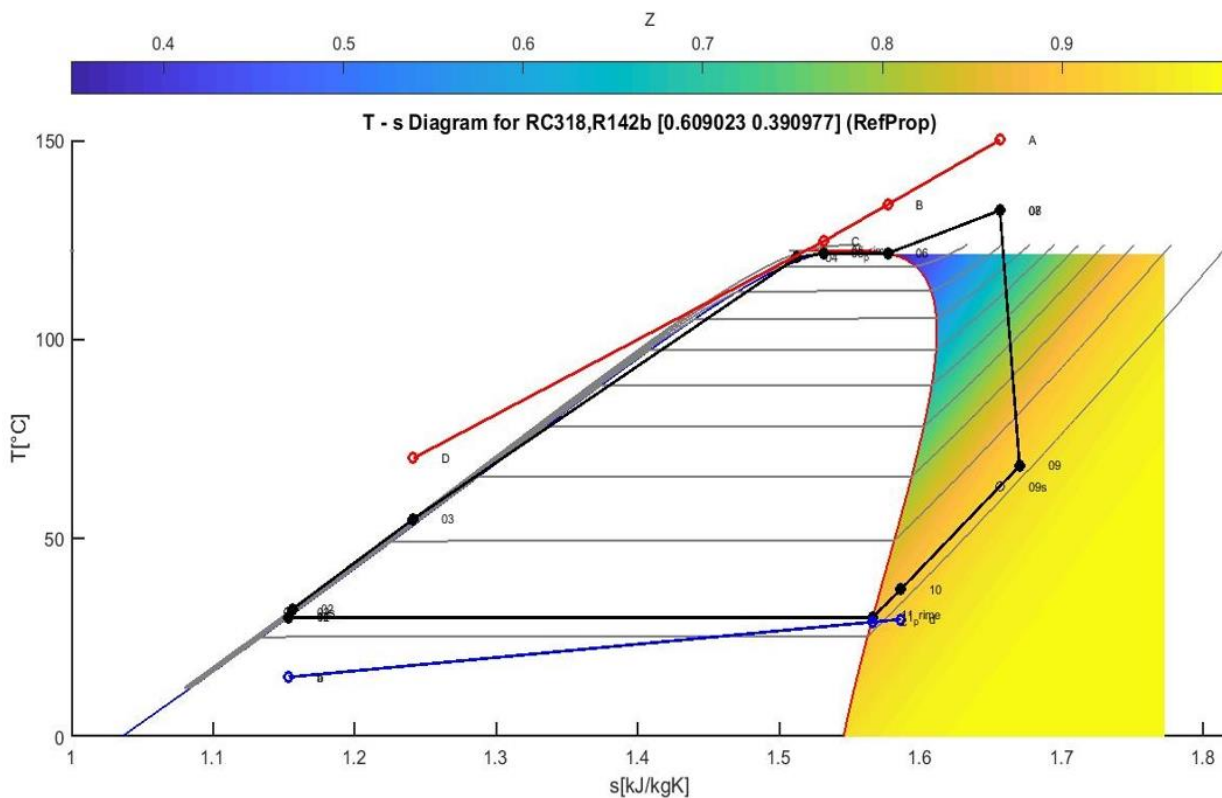

Figure 15. T-s diagram for mixture RC318 and R142b optimization.

4 VERIFICATION

With the purpose of proving evidences supporting the usefulness of the present work, it has been compared to previous studies. This screening comparison has been performed replicating faithfully the specific scenarios of those studies serving as references.

4.1 Reference studies.

Given the fact that the present study is strongly based on Astolfi et al. [34], the first step to approach verification must be replicating Astolfi's results as the modeling and parametrization matching between them is the highest in comparison to any other work. Thus, the error difference can not only be justified by comparison but also the potential improvements in model, algorithm and results.

In this terms, exhaustive comparison is performed with respect to results of Astolfi et al. [34], which is mainly focused on optimization for geothermal brines in the range of 120-180 °C.

Moreover, to present further verification and rely results on a more solid basis, this study's parametrization has been adapted to D. Maraver et al. [41]. Although presenting different modeling of cycle, it has a strong similarity of the consideration of several configuration scenarios (subcritical/supercritical, regeneration/non-regeneration). The chosen objective function for the mentioned study is the exergy efficiency which has been replicated in the present work as its flexibility allows multiobjective optimization.

All in all, the criteria for each verification is to imitate configurations, parameters and sources to prove its generic capability:

- Subcritical and supercritical solutions
- Screening design parameters
- Regenerative vs. non regenerative
- Temperature profiles of heat source and sink
- Objective functions
- Working fluids

It is crucial to mention that, for the verification purpose the working fluid is fixed whilst any other optimization variable remains unconstrained, with the goal of comparing not only the optimal values of objective functions but the optimization variables as well, thus:

- $P_{in,turb}$
- $\Delta T_{ap,PHE}$

4.2 Verification with Astolfi's study.

As Astolfi's study focuses on the application of ORC to exploit geothermal brines the hot source fluid is water with inlet temperature and specific heat considered to be constant, whilst the sink fluid being air with constant heat capacity.

Several of his analysis could be chosen, nevertheless, in order to aim for the most comprehensive verification each analysis is performed with respect to various fluids, in Astolfi's case these will be:

- RC 318
- C 4 F 10
- R227EA

These will be tested under the same circumstances for different configurations.

4.2.1 Astolfi's verification with reinjection limit.

Being the scenario a 150°C geothermal brine with a reinjection limit of 70°C and ambient temperature of 25°C the optimal solutions for the mentioned organic fluids provided by the present work are shown in Fig 16.

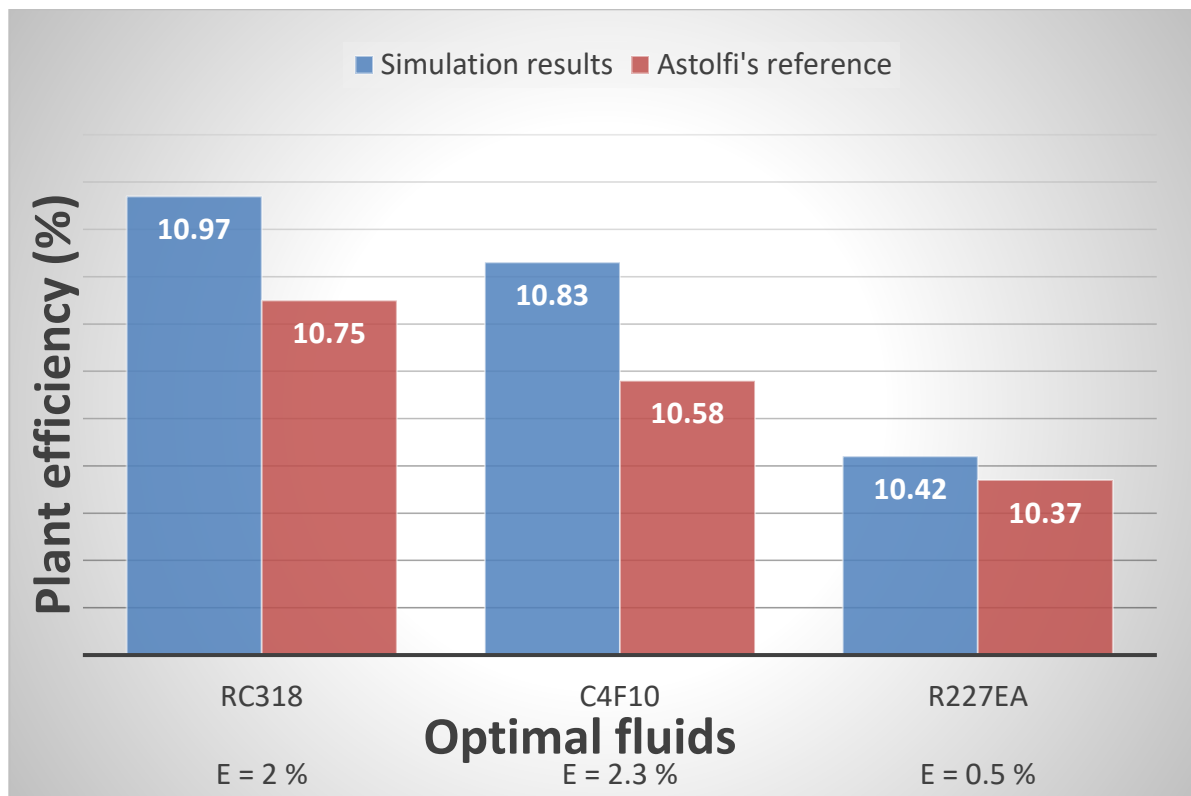

Figure 16. Verification with Astolfi's optimization work, reinjection limit applies.

The optimal configurations for all fo the fluids converge to supercritical and regenerative. The objective function for the optimization is the cycle efficiency η_{cycle} (Eq. 3).

Being the standart deviation:

$$\sigma = \sqrt{\frac{\sum_{i=1}^n (x_i - \bar{x})^2}{N}} \quad (16)$$

Where:

x_i = Deviation of fluid i

\bar{x} = arithmetic average of all deviations

N = number of fluids

The standard deviation for the current comparison is:

$$\sigma = 0.787 \%$$

4.2.2 Astolfi's verification with NO reinjection limit.

Scenario is a 150°C geothermal brine with no reinjection limit and an ambient temperature of 15°C the optimal solutions for the mentioned organic fluids provided by the present work are shown in Fig 15.

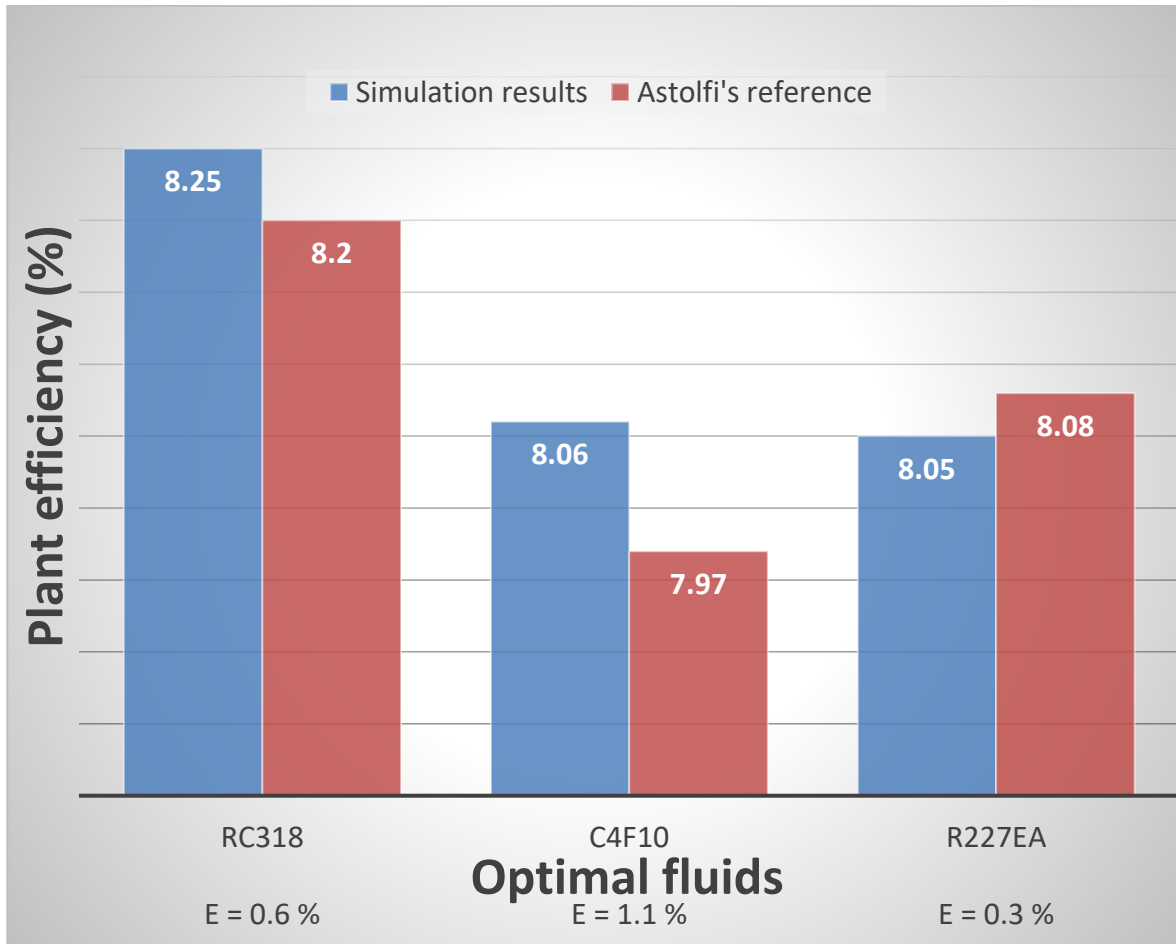

Figure 17. Verification with Astolfis optimization work, no reinjection limit.

The optimal configurations for all fo the fluids converge to supercritical and regenerative, whilst the standart deviation for this analysis is:

$$\sigma = 0.315 \%$$

The efficiency improvement with respect to Astolfis results can be justified by the genetic algorithm, whose heuristic nature represent an improvement looking for a global optimal.

4.3 Verification with Maraver's study.

In the other hand D. Maraver et al. [41] conducted quite a similar study to the intentions of the present one, focusing on the thermodynamic optimization of organic Rankine cycles (ORCs) for power generation and CHP for a wide range of heat source profiles (waste heat recovery, thermal oil for cogeneration and geothermal). The general was providing guidelines for several operating conditions, including subcritical and transcritical, regenerative and non-regenerative cycles, thus it matches the goals of this work.

Maraver also performed a parametrization of the equipment in the cycle (expander, heat exchangers and feed pump). An optimization model of the ORC. Nonetheless one of the main differences in the approach is that Maraver decided to optimize in terms of exergy efficiency, but as previously said this represents no obstacle.

Finally, criterion to decide the fluids to be employed in the comparison was to run those considered the most commonly used in commercial ORC units (R134a, R245fa, Solkatherm, n-Pentane, Octamethyltrisiloxane and Toluene), Fig 16 shows verification for R134a, R245fa and n-Pentane.

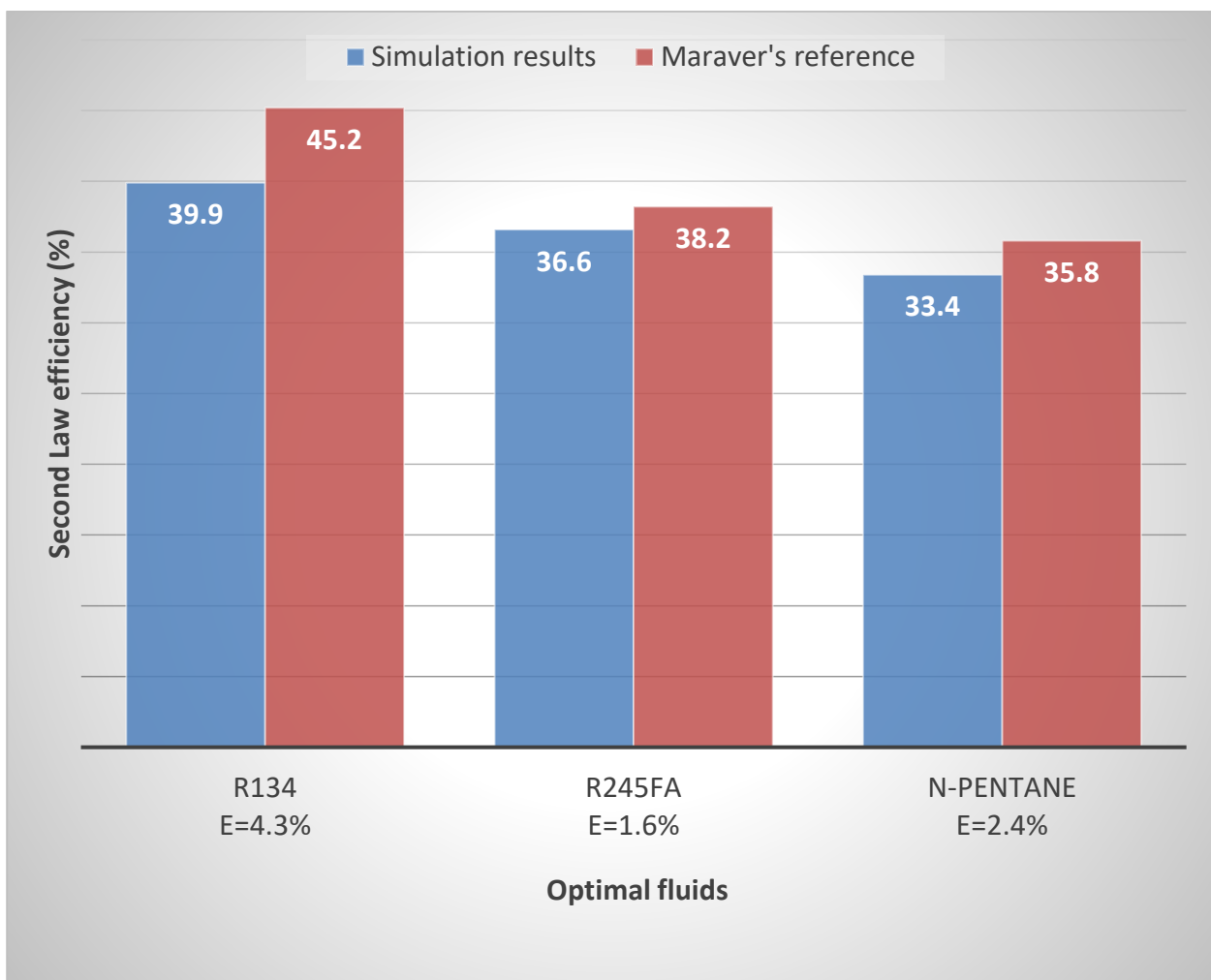

Figure 18. Verification with Maraver optimization work.

In this case the analysis is performed for a 170 °C geothermal source with a reinjection limit of 70 °C and a cold sink of 10 °C air.

The configuration results are as follows:

- For R134 it is a supercritical non-regenerative ORC
- For R245FA it is a subcritical non-regenerative ORC
- For N-PENTANE it is a subcritical non-regenerative ORC

Overall standard deviation is:

$$\sigma = 1.385 \%$$

The deviation increases in comparison to Astolfis verification, this is due to the strong mirroring of this study with respect to Astolfis and the differences in modeling assumptions as losses coefficients, mass flow calculations and optimization algorithm, yet the standard deviation remains low enough to consider it quite a valid and successful verification.

4.4 Observations on verification process.

Given the low deviation and screening configurations for comparison purposes, this matching optimization results are considered to represent valid verification for the present work, thus represents a trustful tool to perform further analysis with binary mixtures.

5 RESULTS

Once generic optimization has been verified for pure fluids, the algorithm is adapted and run for the optimization of binary zeotropic mixtures. The thermodynamic state will be computed according to database applying mixture rules to the pure-fluid Helmholtz energies with relation to their molar fractions. The algorithm compares each binary combination of the provided input fluids and results in the best combination and molar fractions of optimal mixture.

5.1 Guidelines for mixture optimization.

When optimizing pure fluids, it is relatively simple to choose a set of potential fluids once the heat source has been defined, it has been proven that fluids whose critical temperature is the closest (but not over) the heat source, provide the best efficiencies as the heat absorption results to be the most profitable.

A good parameter for the analysis of this is the $T_{crit} / T_{hot\ source}$ ratio, Astolfi et al. [34] found there is a convenient range between 0.88 and 0.92, this is easier for pure fluids than for mixture since the different components of mixtures and the influence of molar fraction compositions has a strong impact on the properties of the resulting mixture, for this reason a more accurate screening criteria is needed when performing mixture analysis, otherwise the computational time can be unfeasible or very tedious.

Consequently, fluids whose critical temperature is above the heat source are strongly recommended since the resulting mixture with other fluid with a critical temperature below the heat source can result in a mixture with a better $T_{crit} / T_{hot\ source}$ ratio.

5.2 Mixture optimization results.

With the goal of finding fluids able to provide a better efficiency, thus give computational support to the theory of mixtures, the optimization of several scenarios has been performed. Fig 17 shows the results compared to a scenario from Astolfi et al. [34] optimization, this figure shows a comprehensive comparison between Astolfi's results, current work pure optimization and current work mixture optimization.

For the given analysis the improving fluid has been C4F10 and the mixture optimization has been performed screening with organic fluids of the same family, thus fluorocarbons.

The theoretical scenario is a 120 °C geothermal brine with reinjection limit of 70 °C

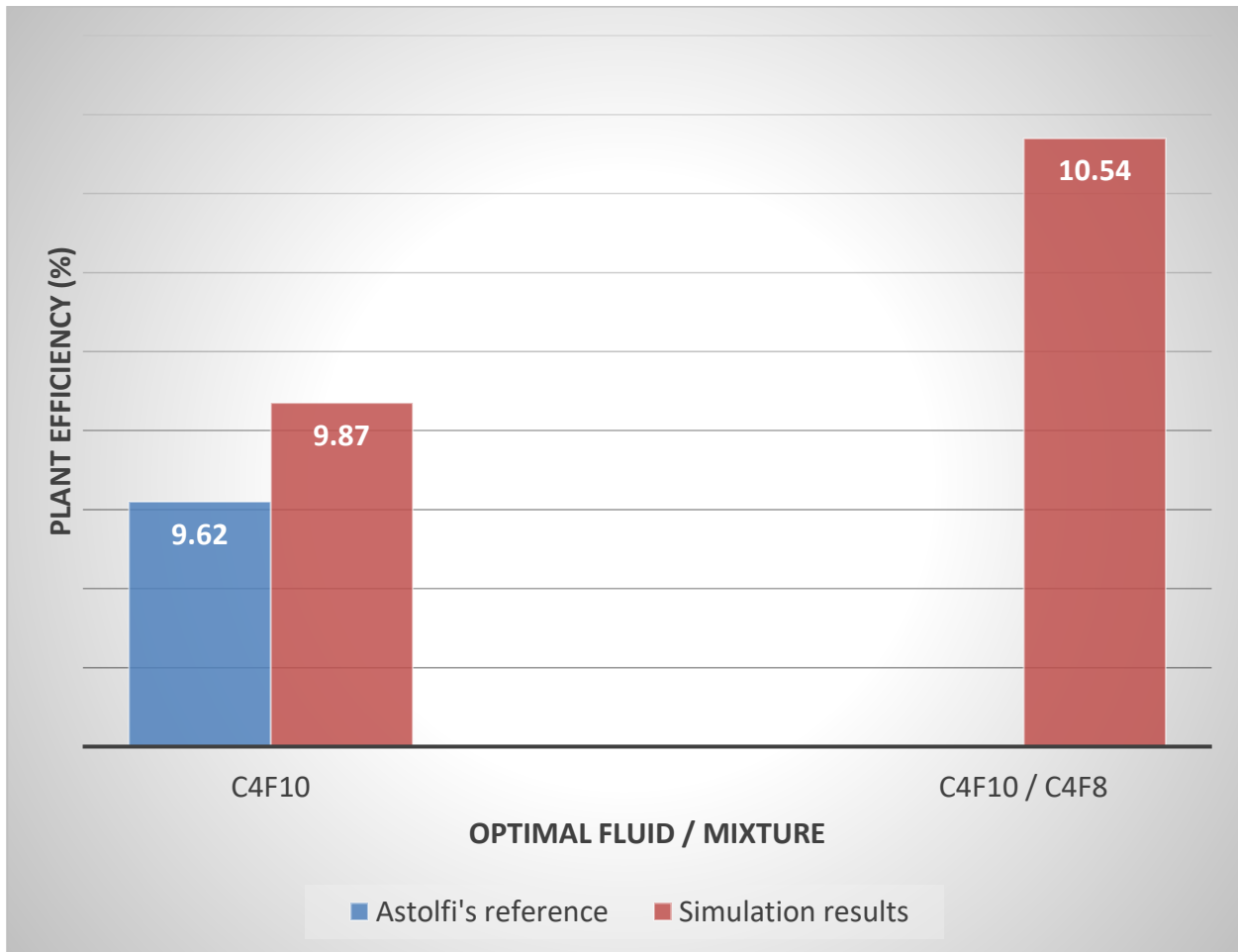

Figure 19. Mixture results.

Results show the best combination within the considered fluorocarbons with similar molecular complexity is C4F10 / C4F8 with corresponding molar fractions of 0.6329 / 0.3671. Original $T_{crit} / T_{hot\ source}$ ratio of C4F10 is $T_{ratio} = 0.983$ whilst the optimal mixture improves it to $T_{ratio} = 0.984$ for an overall improvement in efficiency of 8.7%.

This represents a successful verification of both the tool developed for this work and the theory of mixtures.

5.3 Mixture optimization Outputs.

Likewise, pure fluid case, the results of optimization do not remain in numerical data only but graphical diagrams as well, thus, T-s, T-Q for cycle and heat exchanges are provided together with an exhaustive breakdown of all the data in an Excel file.

6 CONCLUSIONS AND FUTURE DEVELOPMENTS

6.1 Conclusions.

- An in-house code has been developed with the aim to simulate Organic Rankine Cycles and analyse their performance, considering both pure fluids and mixtures as working fluid. Code's accuracy and reliability have been proven by means of a verification process against data found in literature. A special emphasis has been dedicated to mixtures optimization, given their growing interest in the scientific community, and to the comparison between mixture and pure fluid cases (both optimized).
- The code developed for this Master thesis results to be a very useful and versatile tool. In fact, besides of optimization of different ORC configurations, it can be adapted to analyse any other scenario that might result interesting to study, simply varying the optimization variables in order to match desired case's boundary conditions.
- Moreover, if needed, this work can be adapted to optimize which ever desired variable of the cycle and perform specific studies as analyzing the evolution of condenser pressure to ambient temperature, cycle efficiency against hot source temperature or the effect of different hot and sink sources for a given working fluid.
- Considering binary mixtures application field, there is still an extense field for investigation and this tool aims to be a first approach for future developments. Supercritical to subcritical configurations seems to have a close relation in these terms as the optimal results show convergence around the saturation line. Fig 20.

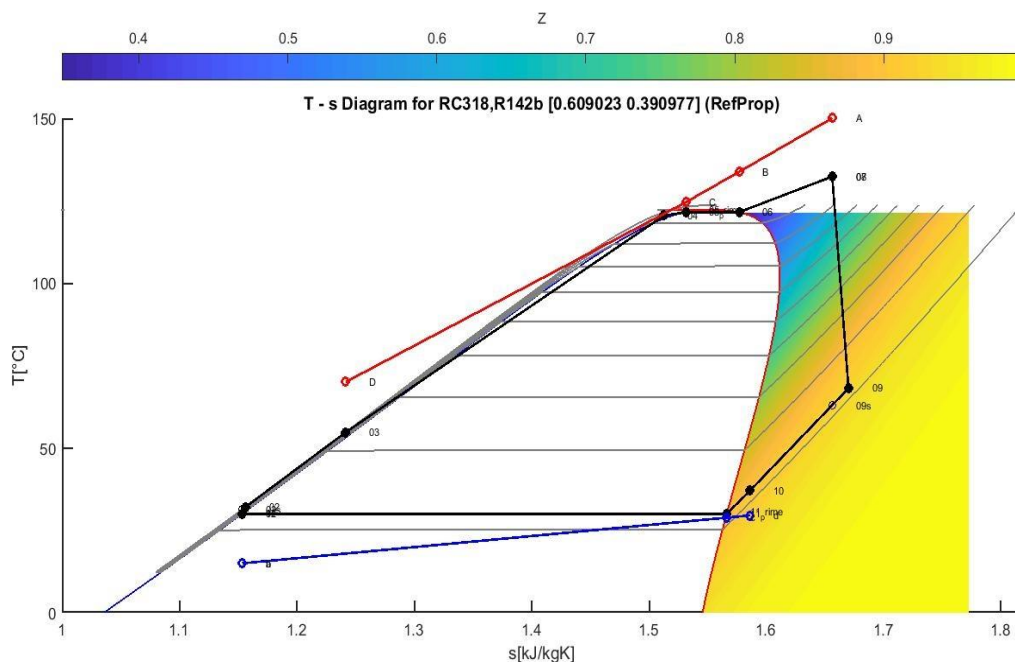

Figure 20. T-s Diagram for a mixture of RC318 and R142B.

- Finally, it has been acknowledged that low temperature heat sources converge to subcritical saturated cycles whilst high temperature profiles converge to supercritical configurations, and the use of recuperator is best convenient when reinjection limits apply. Nevertheless, the higher efficiencies in terms of absolute values are reached under supercritical configurations, thus under the higher heat source temperatures.

6.2 Future developments.

- The parametrization of mathematical optimization method (i.e. Genetic algorithm) has proven to have a strong influence on finding a global optimal and the computational time, future analysis of different parameters as initial population, variable bounds and constraints seems to represent a interesting topic to improve the algorithm adaptability.
- This work code has been developed with an intentional modular architecture, hoping to be the basis to a more complex tool to be supplemented with specific models for each equipment (i.e. turbine, pump and heat exchangers).
- There is an enormous concern regarding the solubility and thermal stability of mixtures, although this work converges to an optimal mixture (selection of fluids) and an optimal composition (molar concentrations) there is still a lot of investigation to be made in order to determine if that theoretical mixture is indeed a feasible working fluid.

REFERENCES

- [1] – MATLAB version 9.3.0. Natick, Massachusetts: The MathWorks Inc; 2017.
- [2] – Lemmon EW, Huber ML, McLinden MO. NIST standard reference database 23: reference fluid thermodynamic and transport properties-REFPROP, version 9.1. Gaithersburg: National Institute of Standards and Technology, Standard Reference Data Program; 2010.
- [3] – Tchanche BF, Lambrinos G, Frangoudakis A, Papadakis G. Low-grade heat conversion into power using organic rankine cycles e a review of various applications. *Renew Sustain Energy Rev* 2009;15(8):3963e79.
- [4] – Rayegan R, Tao YX. A procedure to select working fluids for solar organic Rankine cycles (ORCs). *Renew Energy* 2011;36(2):659e70.
- [5] – Quoilin S, Orosz M, Hemond H, Lemort V. Performance and design optimization of a low-cost solar organic Rankine cycle. *Solar Energy* 2011;85(5): 955e66.
- [6] – Invernizzi C, Bombarda P. Thermodynamic performance of selected HCFs for geothermal applications. *Energy* 1997;22(9):887e95.
- [7] – Hettiarachchi HDM, Golubovic M, Worek WM, Ikegami Y. Optimum design criteria for an organic Rankine cycle using low-temperature geothermal heat sources. *Energy* 2007;32:1698e706.
- [8] – Saleh B, Koglbauer G, Wendland M, Fischer J. Working fluids for lowtemperature organic Rankine cycles. *Appl Therm Eng* 2011;31(14e15): 2885e93.
- [9] – Drescher U, Brüggemann D. Fluid selection for the organic Rankine cycle (ORC) in biomass power and heat plants. *Appl Therm Eng* 2007;27:223e8.
- [10] – Invernizzi C, Iora P, Silva P. Bottoming micro-Rankine cycles for micro-gas turbines. *Appl Therm Eng* 2007;27(1):100e10.
- [11] – Dai Y, Wang J, Gao L. Parametric optimization and comparative study of organic rankine cycle (ORC) for low grade waste heat recovery. *Energy Convers Manag* 2009;50:576e82.
- [12] – Lakew A, Bolland O. Working fluids for low-temperature heat source. *Appl Therm Eng* 2010;30(10):1262e8.
- [13] – Tchanche BF, Lambrinos G, Frangoudakis A, Papadakis G. Low-grade heat conversion into power using organic Rankine cycles - a review of various applications. *Renew Sust Energy Rev* 2011;15(8):3963-79.
- [14] – Vélez F, Segovia JJ, Martín MC, Antolín G, Chejne F, Quijano A. A technical, economical and market review of organic Rankine cycles for the conversion of low-grade heat for power generation. *Renew Sust Energy Rev* 2012;16 (6):4175-89.
- [15] – Schuster A, Karellas S, Kakaras E, Spliethoff H. Energetic and economic investigation of Organic Rankine Cycle applications. *Applied Thermal Engineering* 2009;29:1809e17.
- [16] – Larjola J. Electricity from industrial waste heat using high-speed organic Rankine cycle (ORC). *International Journal of Production Economics* 1995;41: 227e35.
- [17] – Yamamoto T, Furuhashi T, Arai N. Design and testing of the Organic Rankine Cycle. *Energy* 2001;26:239e51.
- [18] – Scaccabarozzi R, Tavano M, Invernizzi CM, Martelli E. Thermodynamic Optimization of heat recovery ORCs for heavy duty Internal Combustion Engine: pure fluids vs. zeotropic mixtures. *Energy Procedia* 129 (2017) 168–175.

- [19] – <http://www.undp.org/content/undp/en/home/sustainable-development/environment-and-natural-capital/montreal-protocol.html>
- [20] – Invernizzi C, Bombarda P. Thermodynamic performance of selected HCFs for geothermal applications. *Energy* 1997;22(9):887e95.
- [21] – Hettiarachchi HDM, Golubovic M, Worek WM, Ikegami Y. Optimum design criteria for an organic Rankine cycle using low-temperature geothermal heat sources. *Energy* 2007;32:1698e706.
- [22] – Uehara H, Ikegami Y. Optimization of a closed-cycle OTEC plant system. *J Solar Eng* 1990;112:247–56.
- [23] – Wei D, Lu X, Lu Z, Gu J. Performance analysis and optimization of organic Rankine cycle (ORC) for waste heat recovery. *Energy Convers Manage* 2007;48:1113–9.
- [24] – Saleh B, Koglbauer G, Wendland M, Fischer J. Working fluids for low temperature organic Rankine cycles. *Energy* 2007;32:1210–21.
- [25] – Ngoc Anh Lai & Thi Thu Huong Phan (2017) Review of the BACKONE equation of state and its applications, *Molecular Physics*, 115:9–12, 1041–1050.
- [26] – Dai Y, Wang J, Gao L. Parametric optimization and comparative study of organic Rankine cycle (ORC) for low grade waste heat recovery. *Energy Conversion and Management* 2009;50:576e82.
- [27] – Holland JH. *Adaptation in nature and artificial systems: an introductory analysis with applications to biology, control and artificial intelligence*. Massachusetts: MIT Press; 1992.
- [28] – Schuster A, Karellas S, Aumann R. Efficiency optimization potential in supercritical organic Rankine cycles. *Energy* 2010;35(2):1033e9.
- [29] – Rashidi MM, Galanis N, Nazari F, Basiri Parsa A, Shamekhi L. Parametric analysis and optimization of regenerative Clausius and organic Rankine cycles with two feedwater heaters using artificial bees colony and artificial neural network. *Energy* 2011;36:5728e40.
- [30] – Roy JP, Mishra MK, Misra A. Parametric optimization and performance analysis of a waste heat recovery system using Organic Rankine Cycle. *Energy* 2010;35:5049e62.
- [31] – Wang ZQ, Zhou NJ, Guo J, Wang XY. Fluid selection and parametric optimization of organic Rankine cycle using low temperature waste heat. *Energy* 2012;40:107e15.
- [32] – Quoilin S, Orosz M, Hemond H, Lemort V. Performance and design optimization of a low-cost solar organic Rankine cycle. *Solar Energy* 2011;85(5): 955e66.
- [33] – T. Guo, H.X. Wang, S.J Zhang. Fluids and parameters optimization for a novel cogeneration system driven by low-temperature geothermal sources. *Energy* 36 (2011) 2639e2649.
- [34] – Marco Astolfi, Matteo C. Romano, Paola Bombarda, Ennio Macchi. Binary ORC (organic Rankine cycles) power plants for the exploitation of medium-low temperature geothermal sources e Part A: Thermodynamic optimization. *Energy* 66 (2014) 423e434.
- [35] – Domenico Scardigno, Emanuele Fanelli, Annarita Viggiano, Giacobbe Braccio, Vinicio Magi. A genetic optimization of a hybrid organic Rankine plant for solar and low-grade energy sources. *Energy* 91 (2015) 807e815.
- [36] – Sonntag RE, Borgnakke G, Van wylen J. *Fundamentals of thermodynamics*. New York: John Wiley & Sons, Inc; 1998.
- [37] – Wolfgang R. Huster, Dominik Bongartz, Alexander Mitsos. Deterministic global optimization of the design of a geothermal rankine cycle. *Energy Procedia* 00 (2017) 000–000.
- [38] – A.Mitsos, B.Chachuat, P.I.Barton, McCormick
Based Relaxations of Algorithms, *SIAM Journal on Optimization* 20(2)(2009)573–601.
- [39] – R.Horst, T.Hoang, *Global optimization: Deterministic approaches*, 3rd Edition, Springer, Berlin and New Yrk, 1996.

- [40] – R. Scaccabarozzi, M. Tavano, C.M. Invernizzi, E. Martelli. Thermodynamic Optimization of heat recovery ORCs for heavy duty Internal Combustion Engine: pure fluids vs. zeotropic mixtures. *Energy Procedia* 129 (2017) 168 – 175.
- [41] – D. Maraver, J. Royo, V. Lemort, S. Quoilin. Systematic optimization of subcritical and transcritical organic Rankine cycles (ORCs) constrained by technical parameters in multiple applications. *Applied Energy* 117 (2014) 11–29.
- [42] – Florian Heberle, Markus Preißinger, Dieter Brüggemann. Zeotropic mixtures as working fluids in Organic Rankine Cycles for low-enthalpy geothermal resources. *Renewable Energy* 37 (2012) 364e370.
- [43] – J. Schilling, M. Entrup, M. Hopp, J. Gross, A. Bardow. Towards optimal mixtures of working fluids: Integrated design of processes and mixtures for Organic Rankine Cycles

